

**SYSMAC**  
**CXONE-AL□□C-V3/**  
**CXONE-AL□□D-V3**

**CX-Position Ver. 2.5**

# **OPERATION MANUAL**

**OMRON**

**CXONE-AL□□C-V3/**

**CXONE-AL□□D-V3**

**CX-Position Ver. 2.5**

**Operation Manual**

*Revised June 2008*





## **Notice:**

OMRON products are manufactured for use according to proper procedures by a qualified operator and only for the purposes described in this manual.

The following conventions are used to indicate and classify precautions in this manual. Always heed the information provided with them. Failure to heed precautions can result in injury to people or damage to property.

 **DANGER** Indicates an imminently hazardous situation which, if not avoided, will result in death or serious injury. Additionally, there may be severe property damage.

 **WARNING** Indicates a potentially hazardous situation which, if not avoided, could result in death or serious injury. Additional, there may be severe property damage.

 **Caution** Indicates a potentially hazardous situation which, if not avoided, may result in minor or moderate injury, or property damage.

## **OMRON Product References**

All OMRON products are capitalized in this manual. The word “Unit” is also capitalized when it refers to an OMRON product, regardless of whether or not it appears in the proper name of the product.

The abbreviation “Ch,” which appears in some displays and on some OMRON products, often means “word” and is abbreviated “Wd” in documentation in this sense.

The abbreviation “PLC” means Programmable Controller.

## **Visual Aids**

The following headings appear in the left column of the manual to help you locate different types of information.

**Note** Indicates information of particular interest for efficient and convenient operation of the product.

**1,2,3...** 1. Indicates lists of one sort or another, such as procedures, checklists, etc.

## **© OMRON, 2004**

All rights reserved. No part of this publication may be reproduced, stored in a retrieval system, or transmitted, in any form, or by any means, mechanical, electronic, photocopying, recording, or otherwise, without the prior written permission of OMRON.

No patent liability is assumed with respect to the use of the information contained herein. Moreover, because OMRON is constantly striving to improve its high-quality products, the information contained in this manual is subject to change without notice. Every precaution has been taken in the preparation of this manual. Nevertheless, OMRON assumes no responsibility for errors or omissions. Neither is any liability assumed for damages resulting from the use of the information contained in this publication.

# Unit Versions of Position Control Units

## Unit Versions

A “unit version” has been introduced to manage Position Control Units according to differences in functionality accompanying Unit upgrades.

### Notation of Unit Versions on Products

The unit version is given to the right of the lot number on the nameplate of the applicable Position Control Units, as shown below.

Example: CS-series Position Control Unit

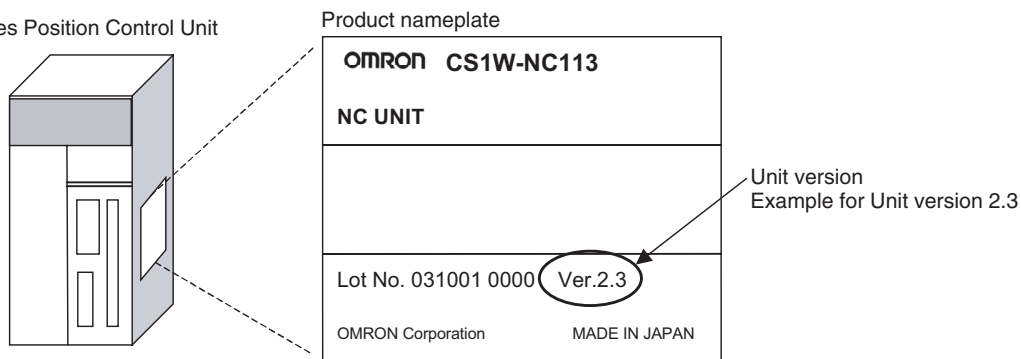

The unit version of the Position Control Units begins at version 2.0.

### Confirming Unit Versions with Support Software

CX-Programmer version 4.0 or higher can be used to confirm the unit version using the **Unit Manufacturing information** command.

1,2,3...

1. In the *IO Table Window*, right-click and select **Unit Manufacturing information - CPU Unit**.
2. The following *Unit Manufacturing information* Dialog Box will be displayed

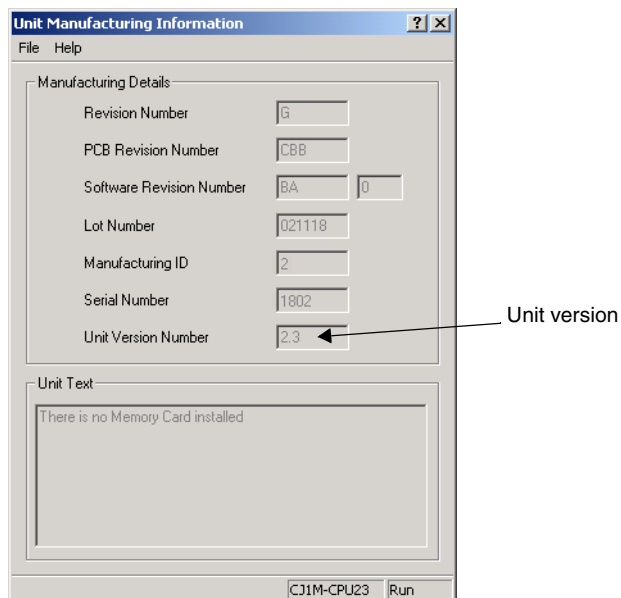

Example for unit version 2.3

Use the above display to confirm the unit version of the Position Control Unit connected online.

### Using the Unit Version Labels

The following unit version labels are provided with the Position Control Unit. These labels can be attached to the front of the Position Control Unit to differentiate between Position Control Units of different unit versions.

## Function Support by Unit Version

### Version Upgrade from Pre-version 2.0 to Position Control Units with Unit Version 2.0

Unit version		Pre-version 2.0 Position Control Units	Position Control Units with unit version 2.0
Internal system software version		1.0	2.0
CS-series Position Control Units		CS1W-NC113/133/213/233/413/433	CS1W-NC113/133/213/233/413/433
CJ-series Position Control Units		CJ1W-NC113/133/213/233/413/433	CJ1W-NC113/133/213/233/413/433
Functions	Changing rates of acceleration when starting multiple axes during relative or absolute movements in direct operation	---	OK
	Changing rates of acceleration/deceleration while jogging	---	OK
	Setting acceleration/deceleration times as the time required to reach the target speed	---	OK
	Simple backup function	---	OK
Support Software		CX-Position Ver. 1.0 or higher	CX-Position Ver. 1.0 (See note.) CX-Position Ver. 2.0 or higher

**Note** With CX-Position version 1.0, new functions added to Position Control Units with unit version 2.0 or later cannot be used.

### Version Upgrade from Unit Version 2.0 to Unit Version 2.1

Unit version		Position Control Units with unit version 2.0	Position Control Units with unit version 2.1
Internal system software version		2.0	2.1
CS-series Position Control Units		CS1W-NC113/133/213/233/413/433	CS1W-NC113/133/213/233/413/433
CJ-series Position Control Units		CJ1W-NC113/133/213/233/413/433	---
Functions	Unused axis setting (See note 1.)	---	OK
Support Software		CX-Position Ver. 1.0 (See note 2.) CX-Position Ver. 2.0 or higher	CX-Position Ver. 1.0 (See note 2.) CX-Position Ver. 2.0 (See note 3.)

- Note**
1. This setting is made in the DM Area of the CPU Unit.
  2. New functions added to the Position Control Units with unit version 2.0 or later cannot be used on the CX-Position version 1.0.
  3. New functions added to the Position Control Units with unit version 2.1 or later cannot be used on the CX-Position version 2.0.

### Version Upgrade from Unit Version 2.1 to Unit Version 2.2

Unit version		Position Control Units with unit version 2.1	Position Control Units with unit version 2.2
Internal system software version		2.1	2.2
CS-series Position Control Units		CS1W-NC113/133/213/233/413/433	CS1W-NC113/133/213/233/413/433
CJ-series Position Control Units		---	---
Functions	Switching pulse output direction (CW or CCW)	---	OK
	Reversal mode 3 in origin search operation	---	OK
	Position-preset origin search	---	OK
Support Software		CX-Position Ver. 1.0 (See note 1.) CX-Position Ver 2.0 or higher	CX-Position Ver. 1.0 (See note 1.) CX-Position Ver. 2.0 (See note 2.) CX-Position Ver. 2.1 or higher

- Note**
1. New functions added to the Position Control Units with unit version 2.0 or later cannot be used on the CX-Position version 1.0.
  2. New functions added to the Position Control Units with unit version 2.2 or later cannot be used on the CX-Position version 2.0.

### Version Upgrade from Version 2.2 to Version 2.3

Unit version		Position Control Units with unit version 2.2	Position Control Units with unit version 2.3
Internal system software version		2.2	2.3
CS-series Position Control Units		CS1W-NC113/133/213/233/413/433	CS1W-NC113/133/213/233/413/433
CJ-series Position Control Units		---	CJ1W-NC113/133/213/233/413/433
Functions	Jogging with Support Software	---	OK
	Direct operation	---	OK (See note 1.)
	Origin searches	---	OK (See note 1.)
	Error counter reset output	---	OK
	Parameters or data check at powering ON	---	OK
Support Software		CX-Position Ver. 1.0 (See note 2.) CX-Position Ver. 2.0 (See note 3.) CX-Position Ver. 2.1 or higher	CX-Position Ver. 1.0 (See note 2.) CX-Position Ver. 2.0 (See note 3.) CX-Position Ver. 2.1 (See note 4.) CX-Position Ver. 2.2 (See note 5.) CX-Position Ver. 2.3 or higher

- Note**
1. These functions can be used on the CX-Position version 2.3 or higher.
  2. New functions added to the Position Control Units with unit version 2.0 or later cannot be used on the CX-Position version 1.0.
  3. New functions added to the Position Control Units with unit version 2.2 or later cannot be used on the CX-Position version 2.0.
  4. New functions added to the Position Control Units with unit version 2.3 or later cannot be used on the CX-Position version 2.1.
  5. Direct operation and origin searches, which were added to Position Control Units with unit version 2.3 or later, cannot be used on the CX-Position version 2.2.

### Position Control Unit Unit Versions and Internal Software Versions

In addition to the unit version, which is common to all CS/CJ-series Units, the Position Control Units have an internal software version. The relationship between the unit version and internal software version is shown in the following table.

Item	Unit version	Internal software version
Meaning	This is the unit version used by all CS/CJ-series Units.	This is the internal software version of this Unit.
Confirmation method	Given to the right on the lot number on the Position Control Unit nameplate. Can also be confirmed using the <i>Unit Manufacturing information</i> command from the IO Table Window of the CX-Programmer.	Can be confirmed by pressing the Ctrl+V Keys from the NC Monitor Window of the CX-Position.
Relationship	None given (Pre-version 2.0)	1.0
	Version 2.0	2.0
	Version 2.1	2.1
	Version 2.2	2.2
	Version 2.3	2.3

# Version Upgrade Information

## Improvements from Version 2.4 to Version 2.5

### New Applicable CPU Units

Ver. 2.4	Ver. 2.5
Position Control Units in CS/CJ-series PLCs (excluding CJ2 PLCs), CP-series PLCs, NSJ-series Controllers, and FQM1 Motion Controllers were supported.	Position Control Units in CS/CJ-series PLCs (including CJ2 PLCs), CP-series PLCs, NSJ-series Controllers, and FQM1 Motion Controllers are supported.

## Improvements from Version 2.3 to Version 2.4

### New Applicable OS

Ver. 2.3	Ver. 2.4
The CX-Position supports Windows 98, Me, NT4.0, 2000, and XP.	The CX-Position supports Windows 98, Me, NT4.0, 2000, XP, and Vista.

## Improvements from Version 2.2 to Version 2.3

### Operating Functions Added for Position Control Units with Unit Version 2.3

Ver. 2.2	Ver. 2.3
The CX-Position can execute the following operations. • JOG operations	The CX-Position can execute the following operations. • JOG operations • Origin searches • Direct operation

## Improvements from Version 2.1 to Version 2.2

### Operating Functions Added for Position Control Units with Unit Version 2.3

Ver. 2.1	Ver. 2.2
The CX-Position could not execute JOG operations.	The CX-Position can execute JOG operations.
The CX-Position could not turn ON/OFF the Error Counter Output signal.	The CX-Position can turn ON/OFF the Error Counter Output signal.

## Improvements from Version 2.0 to Version 2.1

### Installing the CX-Position from the CX-One FA Integrated Tool Package

Ver. 2.0	Ver. 2.1
The CX-Position could be installed only independently.	The CX-Position can be installed as one of the functions of the CX-One FA Integrated Tool Package.

### CX-Position Startup Method

Ver. 2.0	Ver. 2.1
The CX-Position could be started only from the Windows Start Menu.	The CX-Position can also be started by right-clicking one of the following Position Control Units in the I/O Table Window opened from the CX-Programmer that was installed from the CX-One and selecting <i>Start Special Application</i> from the pop-up menu. • CS1W-NC□□□□ • CJ1W-NC□□□□ <b>Note</b> When <i>Start with Settings Inherited</i> is selected, a new project will be created, the device type setting will be automatically performed, and a Position Control Unit will be automatically added.



## Improvements from Version 1.0 to Version 2.0

The CX-Position has been upgraded from version 1.00 to version 2.00. See the contents in the following table.

Item	Existing version (Ver. 1.00)	New version (Ver. 2.00)
Model	WS02-NCTC1-E	WS02-NCTC1-EV2
Communications driver	FinsGateway	CX-Server
OS	Windows 95, 98, 2000, NT4.0	Windows 95, 98, 2000, XP, NT4.0

**Note** Due to the change of the communications driver, another PLC Setup will be required when opening a project file created with CX-Position version 1.00 on CX-Position version 2.00. Additionally, data saved with version 2.00 format cannot be read with version 1.00.

# TABLE OF CONTENTS

<b>PRECAUTIONS</b> .....	<b>xvii</b>
1 Intended Audience .....	xviii
2 General Precautions .....	xviii
3 Safety Precautions.....	xviii
4 Application Precautions .....	xix
5 Operating Environment Precautions .....	xx
<b>SECTION 1</b>	
<b>Overview</b> .....	<b>1</b>
1-1 Introduction.....	2
1-2 System Configuration .....	5
1-3 List of Functions .....	6
1-4 Comparison with SYSMAC-NCT .....	7
1-5 Basic Operating Procedure .....	8
<b>SECTION 2</b>	
<b>Setup and Basic Procedures</b> .....	<b>9</b>
2-1 Installing and Uninstalling the Software.....	10
2-2 Connecting to a PLC .....	10
2-3 Basic Operations .....	17
<b>SECTION 3</b>	
<b>Creating New Projects</b> .....	<b>37</b>
3-1 Creating New Projects.....	38
3-2 Adding and Deleting PLCs .....	40
3-3 Adding and Deleting Position Control Units .....	44
3-4 Automatic Position Control Unit Search .....	45
<b>SECTION 4</b>	
<b>Editing Settings</b> .....	<b>47</b>
4-1 Overview.....	48
4-2 Setting Editing Windows.....	51
4-3 Editing Parameter Settings .....	60
4-4 Editing Sequence Settings.....	61
4-5 Editing Speed Settings .....	63
4-6 Editing Acceleration/Deceleration Time Settings.....	64
4-7 Editing Dwell Time Settings .....	65
4-8 Editing Zone Settings .....	66

# TABLE OF CONTENTS

## SECTION 5

### **Saving and Reading Projects . . . . . 67**

- 5-1 Saving Projects . . . . . 68
- 5-2 Reading Projects . . . . . 68

## SECTION 6

### **Transferring and Verifying Data . . . . . 71**

- 6-1 Default Configurations for Connecting Online . . . . . 72
- 6-2 Setting and Changing Communications Specifications . . . . . 72
- 6-3 Downloading Data . . . . . 75
- 6-4 Uploading Data . . . . . 76
- 6-5 Verifying Data . . . . . 78
- 6-6 Writing Data to Flash Memory . . . . . 80

## SECTION 7

### **Monitoring Position Control Units . . . . . 81**

- 7-1 Monitoring Position Control Units . . . . . 82
- 7-2 Multiple Unit Monitoring . . . . . 83
- 7-3 Operating Memory Area Monitoring . . . . . 84
- 7-4 Operating Data Area Monitoring . . . . . 84

## SECTION 8

### **Test Run Operation . . . . . 87**

- 8-1 Test Run Settings . . . . . 88
- 8-2 Test Run . . . . . 88

## SECTION 9

### **Error Counter Reset Output . . . . . 93**

- 9-1 Error Counter Reset Output . . . . . 94

## SECTION 10

### **Printing Data . . . . . 97**

- 10-1 Printing Data . . . . . 98

## SECTION 11

### **Error Logs and Troubleshooting . . . . . 101**

- 11-1 Position Control Unit Error Logs . . . . . 102
- 11-2 Troubleshooting . . . . . 117

### **Revision History . . . . . 119**

## About this Manual:

This manual describes the specifications and operation of the CX-Position software and includes the sections described below. The CX-Position runs on Windows 2000, XP, or Vista operating systems and is used to create data for and monitor the operation of the CS1W-NC□□□ and CJ1W-NC□□□ Position Control Units (also referred to as NC Units).

Please read this manual carefully and be sure you understand the information provided before attempting to install and operate CX-Position. Please read the following manuals carefully and be sure you understand the information provided before using a Position Control Unit.

Model	Manual name	Cat. No.
CXONE-AL□□C-V3 CXONE-AL□□D-V3	CX-Position Operation Manual	W433 (this manual)
CS1W-NC113/213/413/133/233/433	CS1W-NC113/213/413/133/233/433 Position Control Units Operation Manual	W376
CJ1W-NC113/213/413/133/233/433	CJ1W-NC113/213/413/133/233/433 Position Control Units Operation Manual	W397

For details on procedures for installing the CX-Position from the CX-One FA Integrated Tool Package, refer to the *CX-One Ver. 3.0 Setup Manual* provided with CX-One.

Cat. No.	Model	Name	Contents
W463	CXONE-AL□□C-V3/AL□□D-V3	CX-One Ver. 3.0 Setup Manual	Installation and overview of CX-One FA Integrated Tool Package.

**Precautions** provides general precautions for using CX-Position and related devices.

**Section 1** provides an overview of CX-Position, its functions, and the system configuration in which it is used.

**Section 2** provides information about CX-Position installation, connecting to the PLC, and basic operating procedures.

**Section 3** describes the procedures for creating new projects, as well as those for adding and deleting Programmable Controllers (PLCs) and Position Control Units (NCs).

**Section 4** describes the procedures used to edit settings.

**Section 5** provides information about saving and reading files.

**Section 6** provides information on data transfer and verification operations between the CX-Position and Position Control Units, and about operations for writing data transferred to Position Control Units into the Position Control Unit flash memory.

**Section 7** provides information about monitoring Position Control Units. The Position Control Unit's current positions, error codes, and status are displayed on the NC Monitor. Monitor Units are also available, displaying sequence numbers and current positions for up to four Units simultaneously. Operating memory area monitoring, operating data area monitoring, and Position Control Unit error logs can also be displayed. For details on NC error log display, refer to *11-1 Position Control Unit Error Logs*.

**Section 8** section describes the test run operations for each axis.

**Section 9** describes the error counter reset output.

**Section 10** provides information about printing data.

**Section 11** provides information about Position Control Unit error log displays and troubleshooting.

<p> <b>WARNING</b> Failure to read and understand the information provided in this manual may result in personal injury or death, damage to the product, or product failure. Please read each section in its entirety and be sure you understand the information provided in the section and related sections before attempting any of the procedures or operations given.</p>
---



## ***Read and Understand this Manual***

Please read and understand this manual before using the product. Please consult your OMRON representative if you have any questions or comments.

## ***Warranty and Limitations of Liability***

### ***WARRANTY***

- (1) The warranty period for the Software is one year from either the date of purchase or the date on which the Software is delivered to the specified location.
- (2) If the User discovers a defect in the Software (i.e., substantial non-conformity with the manual), and returns it to OMRON within the above warranty period, OMRON will replace the Software without charge by offering media or downloading services from the Internet. And if the User discovers a defect in the media which is attributable to OMRON and returns the Software to OMRON within the above warranty period, OMRON will replace the defective media without charge. If OMRON is unable to replace the defective media or correct the Software, the liability of OMRON and the User's remedy shall be limited to a refund of the license fee paid to OMRON for the Software.

### ***LIMITATIONS OF LIABILITY***

- (1) THE ABOVE WARRANTY SHALL CONSTITUTE THE USER'S SOLE AND EXCLUSIVE REMEDIES AGAINST OMRON AND THERE ARE NO OTHER WARRANTIES, EXPRESSED OR IMPLIED, INCLUDING BUT NOT LIMITED TO, WARRANTY OF MERCHANTABILITY OR FITNESS FOR A PARTICULAR PURPOSE. IN NO EVENT WILL OMRON BE LIABLE FOR ANY LOST PROFITS OR OTHER INDIRECT, INCIDENTAL, SPECIAL, OR CONSEQUENTIAL DAMAGES ARISING OUT OF USE OF THE SOFTWARE.
- (2) OMRON SHALL ASSUME NO LIABILITY FOR DEFECTS IN THE SOFTWARE BASED ON MODIFICATION OR ALTERATION OF THE SOFTWARE BY THE USER OR ANY THIRD PARTY.
- (3) OMRON SHALL ASSUME NO LIABILITY FOR SOFTWARE DEVELOPED BY THE USER OR ANY THIRD PARTY BASED ON THE SOFTWARE OR ANY CONSEQUENCE THEREOF.

## ***Application Considerations***

### ***SUITABILITY FOR USE***

THE USER SHALL NOT USE THE SOFTWARE FOR A PURPOSE THAT IS NOT DESCRIBED IN THE ATTACHED USER MANUAL.

## ***Disclaimers***

### ***CHANGE IN SPECIFICATIONS***

The software specifications and accessories may be changed at any time based on improvements or for other reasons.

### ***EXTENT OF SERVICE***

The license fee of the Software does not include service costs, such as dispatching technical staff.

### ***ERRORS AND OMISSIONS***

The information in this manual has been carefully checked and is believed to be accurate; however, no responsibility is assumed for clerical, typographical, or proofreading errors, or omissions.

# PRECAUTIONS

This section provides general precautions for using CX-Position and related devices.

**The information contained in this section is important for the safe and reliable application of CX-Position. You must read this section and understand the information contained before attempting to set up or operate the CX-Position.**

1	Intended Audience .....	xviii
2	General Precautions .....	xviii
3	Safety Precautions .....	xviii
4	Application Precautions .....	xix
5	Operating Environment Precautions .....	xx



## 1 Intended Audience

This manual is intended for the following personnel, who must also have knowledge of electrical systems (an electrical engineer or the equivalent).

- Personnel in charge of installing FA systems.
- Personnel in charge of designing FA systems.
- Personnel in charge of managing FA systems and facilities.

## 2 General Precautions

The user must operate the product according to the performance specifications described in the operation manuals.

Before using the product under conditions which are not described in the manual or applying the product to nuclear control systems, railroad systems, aviation systems, vehicles, combustion systems, medical equipment, amusement machines, safety equipment, and other systems, machines, and equipment that may have a serious influence on lives and property if used improperly, consult your OMRON representative.

Make sure that the ratings and performance characteristics of the product are sufficient for the systems, machines, and equipment, and be sure to provide the systems, machines, and equipment with double safety mechanisms.

This manual provides information for using CX-Position. Be sure to read this manual before attempting to use CX-Position and keep this manual close at hand for reference during operation.

 **WARNING** It is extremely important that CX-Position and related devices be used for the specified purpose and under the specified conditions, especially in applications that can directly or indirectly affect human life. You must consult with your OMRON representative before applying CX-Position and related devices to the above mentioned applications.

## 3 Safety Precautions

 **WARNING** Never attempt to disassemble any Units while power is being supplied. Doing so may result in serious electric shock.

 **WARNING** Never touch any of the terminals while power is being supplied. Doing so may result in serious electric shock.

 **Caution** Save parameters and other data to flash memory after transferring them to the Position Control Unit. If parameters and other data are not saved to flash memory, data will return to their previous values the next time power is turned ON, possibly resulting in Unit malfunction.

 **Caution** Confirm safety at the destination node before transferring parameters or other data to the node. Transferring parameters or other data without confirming safety may result in injury.

 **Caution** Check that the axis number is correct before operating an axis from the CX-Position.

 **Caution** Do not save data to flash memory during memory operation or while the motor is running. Doing so may result in unexpected operation.

## 4 Application Precautions

 **Caution** Observe the following precautions when using CX-Position.

- Confirm the unit number before transferring parameters and other data to a Position Control Unit.
- Confirm that set parameters and data operate properly before using in actual operation.
- When the settings of the following parameters have been changed, they must be transferred to the Position Control Unit and written to flash memory, and then the Position Control Unit must be turned OFF and back ON, or restarted as a Special I/O Unit, to enable using the new settings.
  - Output pulse selection
  - Output pulse direction
  - Limit input signal type
  - Origin proximity input signal type
  - Origin input signal type
  - Emergency stop input function
  - No-origin specification
  - Operating mode selection
  - Origin search operation
  - Origin detection method
  - Origin search direction
  - Position-preset origin search
- Do not turn OFF the power to a Position Control Unit while writing to flash memory. Doing so may damage flash memory.
- Confirm that no adverse effect will occur in the system before attempting any of the following. Not doing so may result in unexpected operation.
  - Changing the operating mode of the PLC (including the operating mode at startup).
  - Changing the present value of any word or any set value in memory.
  - Force-setting/force-resetting any bit in memory.
- Do not turn OFF the power to the computer while installing or uninstalling CX-Position. Doing so may corrupt computer data.

## 5 Operating Environment Precautions

 **Caution** Perform installation properly, according to the procedures described in this manual.

 **Caution** Do not install in the following locations:

- Locations subject to direct sunlight.
- Locations subject to temperatures or humidity outside the range specified in the specifications.
- Locations subject to condensation as the result of severe changes in temperature.
- Locations subject to corrosive or flammable gases.
- Locations subject to dust (especially iron dust) or salts.
- Locations subject to exposure to water, oil, or chemicals.
- Locations subject to shock or vibration.

 **Caution** Take appropriate and sufficient countermeasures when installing in the following locations:

- Locations subject to static electricity or other forms of noise.
- Locations subject to strong electromagnetic fields.
- Locations subject to possible exposure to radioactivity.
- Locations close to power supplies.

# SECTION 1

## Overview

This section provides an overview of CX-Position, its functions, and the system configuration in which it is used.

1-1	Introduction . . . . .	2
1-1-1	What Is CX-Position? . . . . .	2
1-1-2	Applicable Position Control Units . . . . .	2
1-1-3	Features . . . . .	3
1-1-4	Applicable Computers . . . . .	4
1-1-5	CX-Position Data . . . . .	4
1-1-6	Software Structure . . . . .	4
1-2	System Configuration . . . . .	5
1-3	List of Functions . . . . .	6
1-4	Comparison with SYSMAC-NCT . . . . .	7
1-5	Basic Operating Procedure . . . . .	8

# 1-1 Introduction

## 1-1-1 What Is CX-Position?

The CX-Position is a software package that enables the setting, transfer, storage, and printing of data used with Position Control Units (also referred to as NC Units), as well as monitoring of Position Control Unit operating status.

The CX-Position runs on a Windows 2000, XP, or Vista operating system.

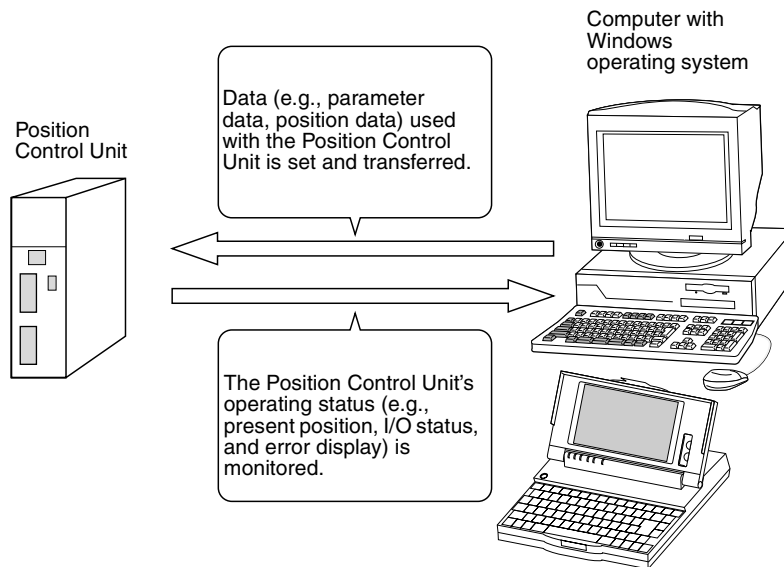

## 1-1-2 Applicable Position Control Units

CX-Position can be used with the following Position Control Units.

Position Control Unit model number	PLC series
CS1W-NC113/133/213/233/413/433	CS Series
CJ1W-NC113/133/213/233/413/433	CJ-series PLCs, CP-series PLCs, NSJ-series NSJ Controllers, and FQM1 Flexible Motion Controllers (See note.)

**Note** The CX-Position supports only FQM1 Flexible Motion Controllers with unit version 3.2 or later.

For details on the system configuration, refer to *1-2 System Configuration*.

## 1-1-3 Features

### Data Management and Editing in Project Units

The CX-Position enables data for several Position Control Units (96 Position Control Units max. per PLC) on several PLCs (1,000 max.) to be handled as 1 project. Data is displayed in tree format with parameter data, sequence data, speed data, acceleration/deceleration data, dwell times, and zone data displayed under the corresponding Position Control Unit, Position Control Units displayed under the corresponding PLC, and PLCs displayed under the corresponding project.

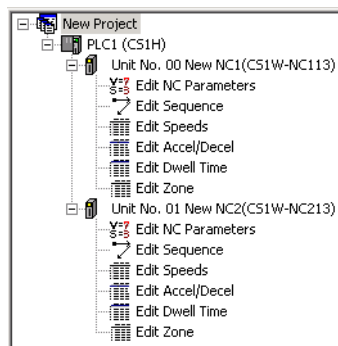

### Individual Copying and Moving of Position Control Unit Data

Position Control Unit data, such as parameters, sequences, and speeds, can be moved or copied (overwritten) between PLCs in the project tree. This feature enables editing and re-use of the same or similar data with other PLCs or Position Control Units.

### Communications with Position Control Units via Networks

The CX-Position communicates with Position Control Units using CX-Server. Depending on the type of CX-Server driver used, online operations (e.g., monitoring and transfer/verification of parameter and sequence data) are possible via Host Link (SYSMAC WAY) or Toolbus.

### Automatic Project Generation

The CX-Position can read information about the Position Control Units mounted on a PLC connected online, and automatically create a project based on this information. (CX-Position can also upload actual data from Position Control Units and use it in the project.) This feature eliminates the necessity of creating a new project offline before going online.

### Importing SYSMAC-NCT Data

Data created for the C200HW-NC□□□ using the SYSMAC-NCT (with .ncm file extension) can be imported and used as data for the CS1W-NC□□□ or CJ1W-NC□□□.

### The CX-One FA integrated Tool Package, which includes the CX-Position, will provide the total solution for a wide range of system development.

The CX-Position can now be started from the I/O Table Window of the CX-Programmer with the communications settings inherited from the CX-Programmer.

Starting the CX-Position with the communications settings inherited will automatically register the communications settings between the PLC and personal computer, Position Control Unit models, unit numbers, and other settings in the CX-Position project file.

Data such as parameters, however, will be initialized.

The CX-Position project files are saved in the same data folder as the CX-Programmer project files, which makes data management easier.

### 1-1-4 Applicable Computers

Refer to the *CX-One Ver. 3.0 Setup Manual (W463)* for the computer system requirements for the CX-Position.

### 1-1-5 CX-Position Data

The CX-Position is used to make project files with the configuration shown below. The file extension for project files is .nci.

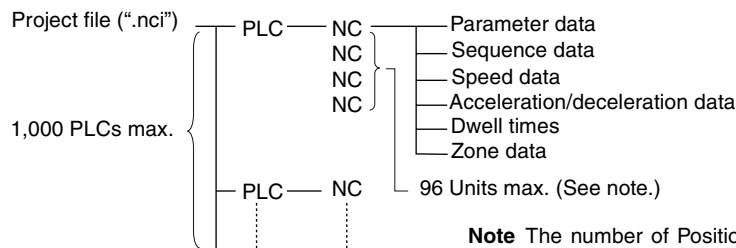

One "PLC" contains the data for 1 PLC (CPU Unit). One project file can contain up to 1,000 PLCs. One "NC" contains all the data for 1 Position Control Unit.

**Note** The number of Position Control Units is restricted by the number of allocated unit numbers and the current consumption.

### 1-1-6 Software Structure

The CX-Position exchanges data (online communications) with Position Control Units via CX-Server. In order to execute functions online, CX-Server must be installed on the same computer as CX-Position.

## 1-2 System Configuration

The system configuration for the Position Control Units is given below with the CS1W-NC413/433 used as a representative example. The CS1W-NC213/233 and CS1W-NC113/133 are used for control of 2 axes and 1 axis respectively.

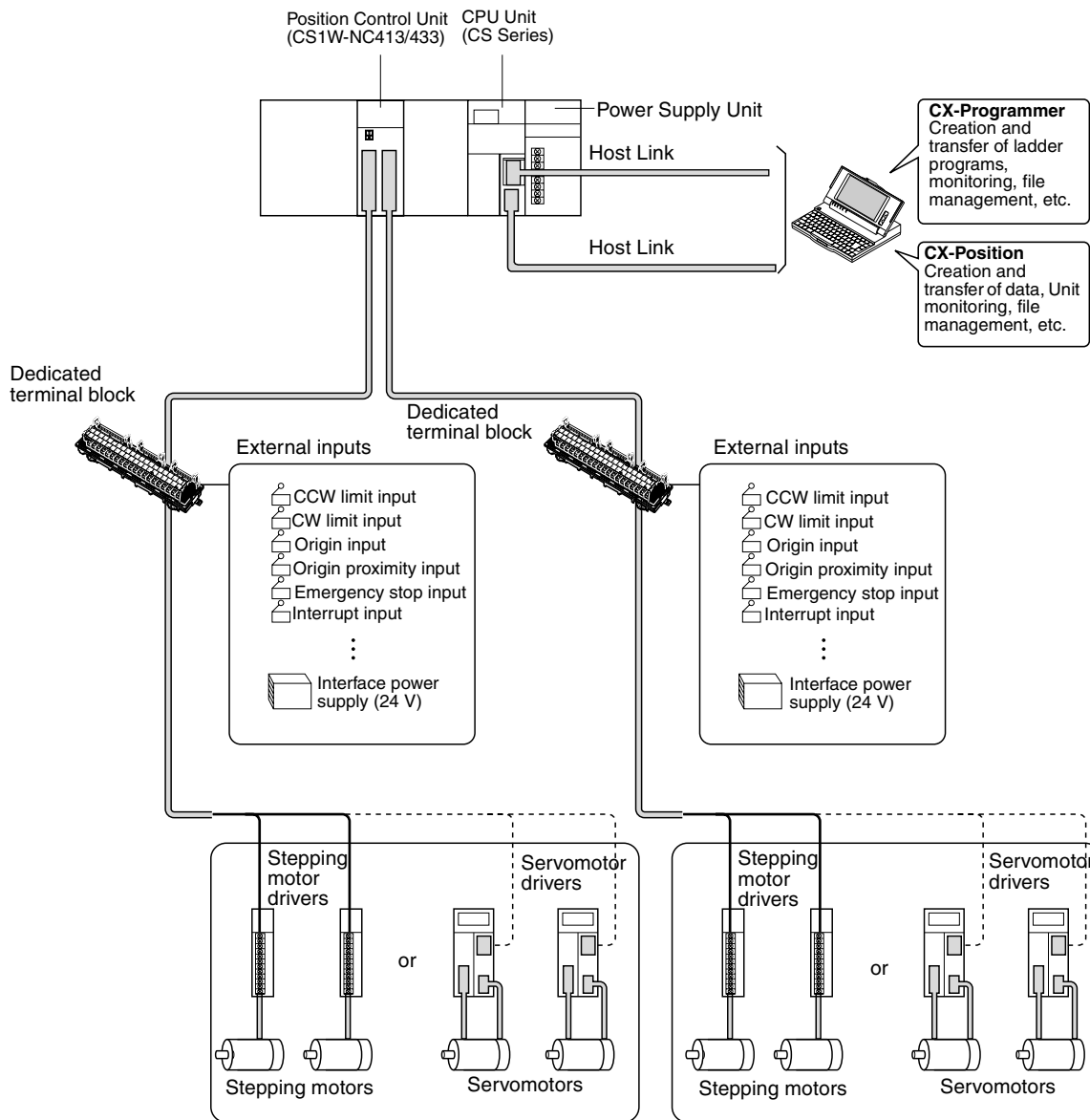

- Note**
1. Special cables are available to connect OMRON U-series Drivers, W-series Drivers, G-series Drivers, SMARTSTEP 2-series Drivers, SMARTSTEP A-series Drivers, or SMARTSTEP Junior Drivers. Cables made by the user can also be used.
  2. Special cables are available for connections to special terminal blocks. Cables made by the user can also be used.



## 1-3 List of Functions

Group	Function	Details	Page	
Editing projects	Create project	Used to create project files (".nci").	page 38	
	Create PLC	Used to specify a PLC model and add PLC data to a project.	page 40	
	Create NC Unit	Used to specify a Position Control Unit model and add Position Control Unit data to a PLC in a project.	page 44	
	Edit PLC/NC Unit	Used to perform editing for a project, such as making property settings for or deleting PLCs or Position Control Units, cutting, copying, or pasting Position Control Units, pasting Position Control Unit data, and drag-and-drop.	page 44	
Editing NC Unit data	Edit	Used to edit the Position Control Unit data shown on the right.	Parameter data	page 60
		Sequence data	page 61	
		Speed data	page 63	
		Acceleration/deceleration time data	page 64	
		Dwell time data	page 65	
		Zone data	page 66	
Saving and loading project files	Save	Used to save all the data in a project as a project file (".nci").	page 68	
	Load	Used to read a project file (".nci") to a project.	page 68	
Importing NCT data files	Import	Used to import data files created with SYSMAC-NCT to CX-Position projects.	page 69	
Online	Download/upload/verify	Used to download, upload, or verify data.	page 75, page 76, page 78	
	Flash memory write	Used to write data to flash memory.	page 80	
	Monitor	Used to display the sequence number, present position, I/O status, and error code for a Position Control Unit.	page 82	
	Monitor Units	Used to display the sequence numbers, present positions, I/O statuses, and error codes for 4 Position Control Units.	page 83	
	Automatic project setting	Used to read information about the Position Control Units mounted on a specified PLC connected online, and creates a project tree based on this. If the data upload checkbox is selected, the data for all Position Control Units on the specified PLC is read and included in the project.	page 45, page 77	
	Operating memory area monitor	Used to monitor the CPU Unit's operating memory area.	page 84	
	Operating data area monitor	Used to monitor the CPU Unit's operating data area.	page 84	
	Test run	Used to execute JOG operations, origin searches, and direct operation.	page 88	
	Error counter reset output	Used to turn ON/OFF the error counter reset output signal.	page 94	
	NC Unit error log monitor	Used to monitor items (20 max. per Position Control Unit) in Position Control Unit error logs.	page 102	

## 1-4 Comparison with SYSMAC-NCT

Item	CX-Position	SYSMAC-NCT
Position Control Unit	CS1W-NC□□□ CJ1W-NC□□□	C200HW-NC□□□ C500-NC□□□
Created files	Project files (".nci") created with the data from more than 1 Position Control Unit mounted on more than 1 PLC (1,000 max.)	Data files (C200HW-NC: ".ncm"; C500-NC: ".ncl") created with the data from 1 Position Control Unit
Managing and editing using projects	Supported Within a project, data can be moved or copied (see note) in units of Position Control Units using "drag-and-drop" and "copy-and-paste" operations. (Data can be moved or copied within the same PLC or between PLCs.) <b>Note</b> The data at the Position Control Unit to which data is copied is overwritten. Icons are not copied along with the data.	Not supported All data is handled together. (Moving and copying in units of Position Control Units is not possible.)
Method for connecting to PLC	<ul style="list-style-type: none"> <li>Connected to the RS-232C port on the CPU Unit or a Serial Communications Board/Unit using an RS-232C cable.</li> <li>Connected to the peripheral port on the CPU Unit using a peripheral cable.</li> </ul>	Connected to the RS-232C port on the CPU Unit using an RS-232C cable.
Networks for connection to PLC	Select from the following for the CX-Server network type to connect to PLCs on networks: <ul style="list-style-type: none"> <li>Toolbus</li> <li>SYSMAC WAY (Host Link)</li> </ul>	Host Link (RS-232C) only
Decimal/binary display selection	Supported.	Not supported (decimal only).
Changing display font size	Supported.	Not supported.
Position Control Unit error log display	Supported.	Not supported.

# 1-5 Basic Operating Procedure

A basic outline of the procedures required to install the CX-Position and CX-Server, create data, transfer it to the Position Control Units, and use in actual operation is given below.

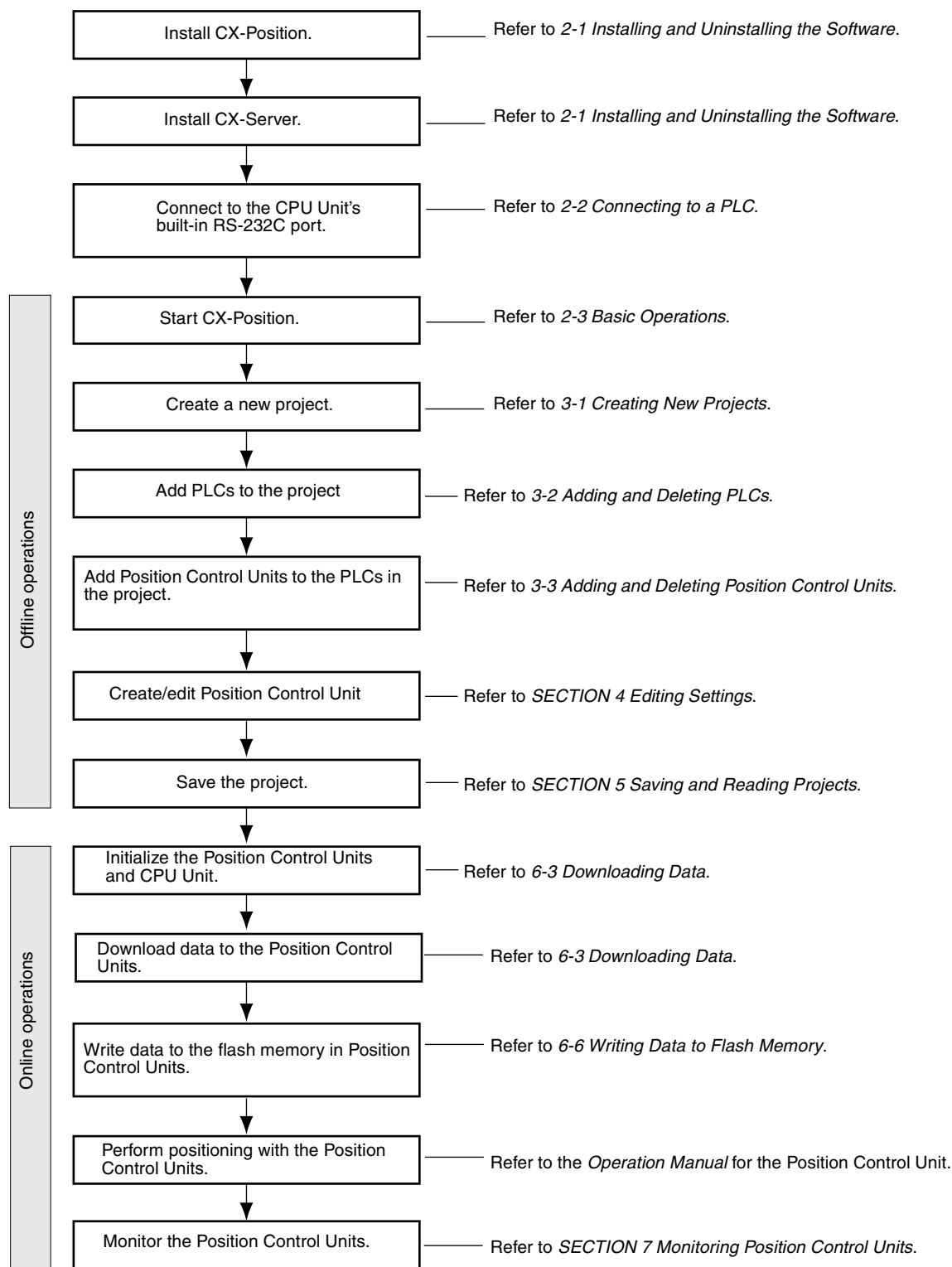

# SECTION 2

## Setup and Basic Procedures

This section provides information about CX-Position installation, connecting to the PLC, and basic operating procedures.

2-1	Installing and Uninstalling the Software.....	10
2-1-1	Software That Must Be Installed .....	10
2-2	Connecting to a PLC.....	10
2-2-1	Connecting to CS/CJ-series PLCs .....	10
2-2-2	Connecting to CP-series PLCs .....	15
2-2-3	Connecting to CJ2 PLCs.....	16
2-3	Basic Operations.....	17
2-3-1	Starting .....	17
2-3-2	Quitting.....	17
2-3-3	Basic Window.....	18
2-3-4	Displaying Menus.....	20
2-3-5	Moving and Copying Position Control Unit Data .....	20
2-3-6	Main Menus .....	23
2-3-7	Main Menu Items .....	24
2-3-8	Operations Listed by Purpose.....	27
2-3-9	Toolbar .....	30
2-3-10	Status Bar .....	30
2-3-11	Option Settings.....	31
2-3-12	View Settings .....	32
2-3-13	Help.....	32

## 2-1 Installing and Uninstalling the Software

### 2-1-1 Software That Must Be Installed

The following software must be installed on the same computer to use the CX-Position.

- 1,2,3...
1. CX-Position
  2. CX-Server (the communications driver)

#### Installing CX-Position

Refer to the *CX-One Ver. 3.0 Setup Manual* (Cat. No. W463) (supplied with the CX-One FA Integrated Tool Package) for information on how to install or uninstall the CX-Position from the CX-One FA Integrated Tool Package.

Cat. No.	Model	Manual name	Contents
W463	CXONE-AL□□C-V3/ AL□□D-V3	CX-One Ver. 3.0 Setup Manual	An overview of the CX-One FA Integrated Tool Package and the CX-One installation procedure

## 2-2 Connecting to a PLC

To transfer the product data created with the CX-Position to a Position Control Unit, the computer must be connected to the CPU Unit of the PLC with a cable and the CX-Position must be placed online with the Position Control Unit.

### 2-2-1 Connecting to CS/CJ-series PLCs

#### Connection Format

- Connecting to the peripheral port on the CPU Unit

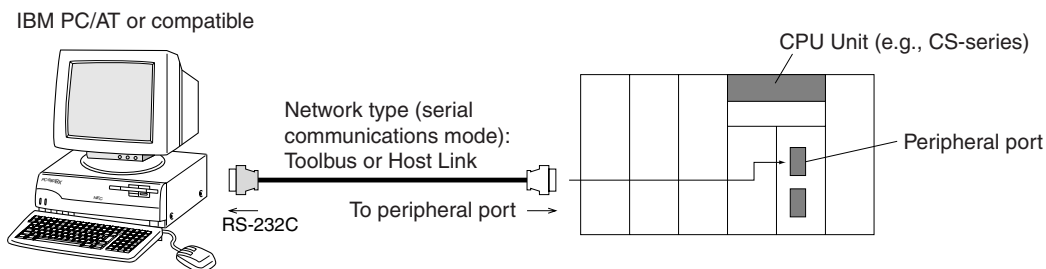

**Note** To connect an IBM PC/AT or compatible to the CPU Unit, additional conversion cables or connectors may be required. For details, see *Connection Method*.

- Connecting to the RS-232C port on the CPU Unit

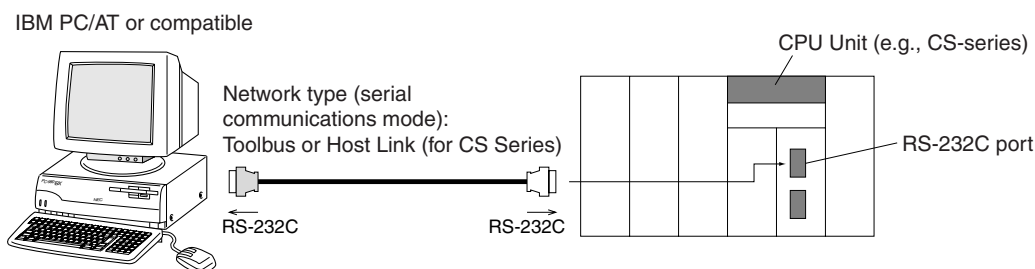

**Note** To connect an IBM PC/AT or compatible to the CPU Unit, additional conversion cables or connectors may be required. For details, see *Connection Method*.

**Connection Method**

The personal computer is connected to the peripheral port or the built-in RS-232C port on the CPU Unit. Two network types, SYSMAC WAY (Host Link) and Toolbus, are available.

**Note** With CS/CJ-series PLCs, a personal computer can be connected to ports on Serial Communications Units/Boards. In this case, SYSMAC WAY (Host Link) is the only supported network type.

**Connecting Personal Computer (CX-Position) to CS/CJ-series CPU Units**

Connecting to Peripheral Port

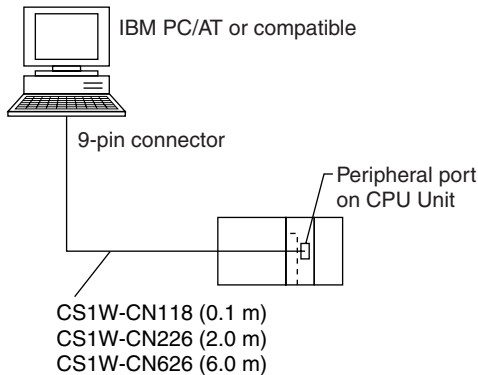

Connecting to RS-232C Port

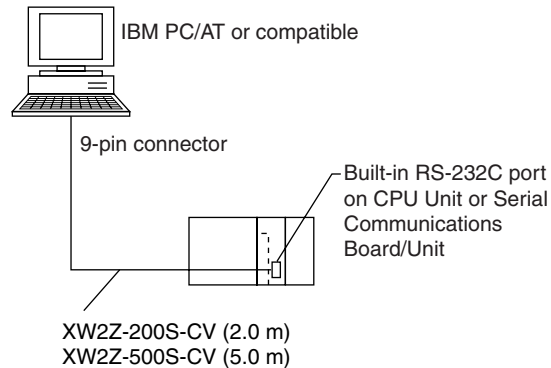

**Connecting Cables**

Unit	Port on Unit	Computer	Port on computer	Network type (serial communications mode)	Model number	Length	Remarks
CPU Unit	Built-in peripheral port	IBM PC/AT or compatible	D-sub, 9-pin, male	Toolbus or SYSMAC WAY (Host Link)	CS1W-CN226	2.0 m	---
					CS1W-CN626	6.0 m	
	Built-in RS-232C port (D-sub, 9-pin, female)				XW2Z-200S-CV	2 m	Uses anti-static connector
					XW2Z-500S-CV	5 m	
Serial Communications Board/Unit	RS-232C port (D-sub, 9-pin, female)			SYSMAC WAY (Host Link)	XW2Z-200S-CV	2 m	Uses anti-static connector
					XW2Z-500S-CV	5 m	

**Note** When connecting the connectors of the above cables to the PLC's RS-232C port, discharge any static build-up (e.g., by touching a grounded metal object) before touching the connectors. Although XW2Z-□□□S-CV Cables use the anti-static XM2S-0911-E Connector Hood (thus reducing the possibility of static build-up), be sure to discharge any static as a safety precaution.

**Other Connection Methods**

**Connecting RS-232C Cable to Peripheral Port**

The following connection methods can be used when connecting an RS-232C cable to the peripheral port.

Unit	Port on Unit	Computer	Port on computer	Network type (serial communications mode)	Model number	Length	Remarks
CPU Unit	Built-in peripheral port	IBM PC/AT or compatible	D-sub, 9-pin, male	Toolbus or SYSMAC WAY (Host Link)	CS1W-CN118 + XW2Z-200S-CV/500-CV	0.1 m (2 m or 5 m)	The XW2Z-□□□S-CV uses an anti-static connector.
				SYSMAC WAY (Host Link)	CS1W-CN118 + XW2Z-200S-V/500-V		---

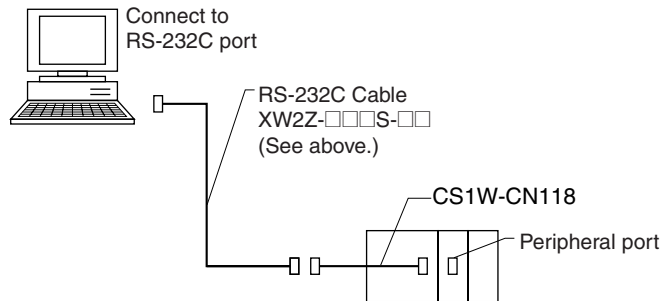

**Connecting CQM1-CIF01/02 to Peripheral Port**

The following connection method can be used when connecting the conventional CQM1-CIF01/02 Cable to the peripheral port.

Unit	Port on Unit	Computer	Port on computer	Network type (serial communications mode)	Model number	Length	Remarks
CPU Unit	Built-in peripheral port	IBM PC/AT or compatible	D-sub, 9-pin, male	SYSMAC WAY (Host Link)	CS1W-CN114 + CQM1-CIF02	0.5 m + 3.3 m	---

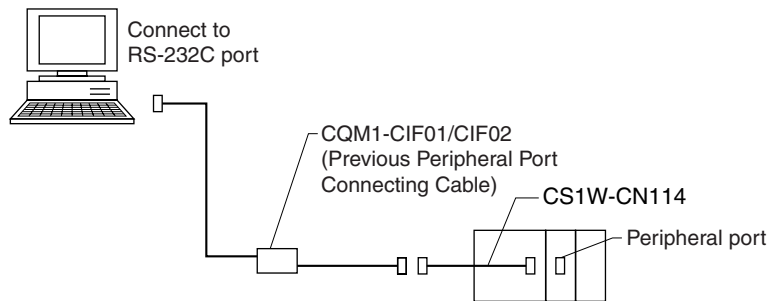

**Connecting a Computer with an RS-232C Cable**

The following connection method can be used when connecting an IBM PC/AT or compatible computer using an RS-232C cable.

Unit	Port on Unit	Computer	Port on computer	Network type (serial communications mode)	Model number	Length	Remarks
CPU Unit	Built-in RS-232C port (D-sub, 9-pin, female)	IBM PC/AT or compatible	D-sub, 9-pin, male	SYSMAC WAY (Host Link)	XW2Z-200S-V	2 m	---
					XW2Z-500S-V	5 m	
Serial Communications Board/Unit	RS-232C port (D-sub, 9-pin, male)				XW2Z-200S-V	2 m	
					XW2Z-500S-V	5 m	

**Note** When connecting an IBM PC/AT or compatible personal computer to the CPU Unit using the USB port on the computer, use the CS1W-CIF31 USB-Serial Conversion Cable (D-sub).

**Making an RS-232C Cable**

For connections with an RS-232C cable, either purchase one of the cables listed above, or make a cable using the connection method and components given below.

**Connector Pin Arrangement**

The pin arrangement for the CPU Unit connector is shown below.

Pin number	Signal abbreviation	Signal name	Signal direction
1	FG	Frame ground	---
2	SD (TXD)	Send data	Output
3	RD (RXD)	Receive data	Input
4	RS (RTS)	Request to send	Output
5	CS (CTS)	Clear to send	Input
6	5V	Power supply	---
7	DR (DSR)	Data set ready	Input
8	ER (DTR)	Data terminal ready	Output
9	SG (0V)	Signal ground	---
Metal cap	FG	Frame ground	---

CS-series Pin Arrangement

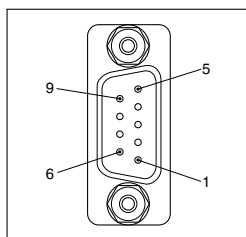

CJ-series Pin Arrangement

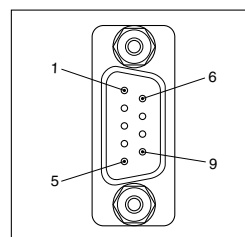



**Connection Method**

Either of the following configurations can be used for connection via Host Link.

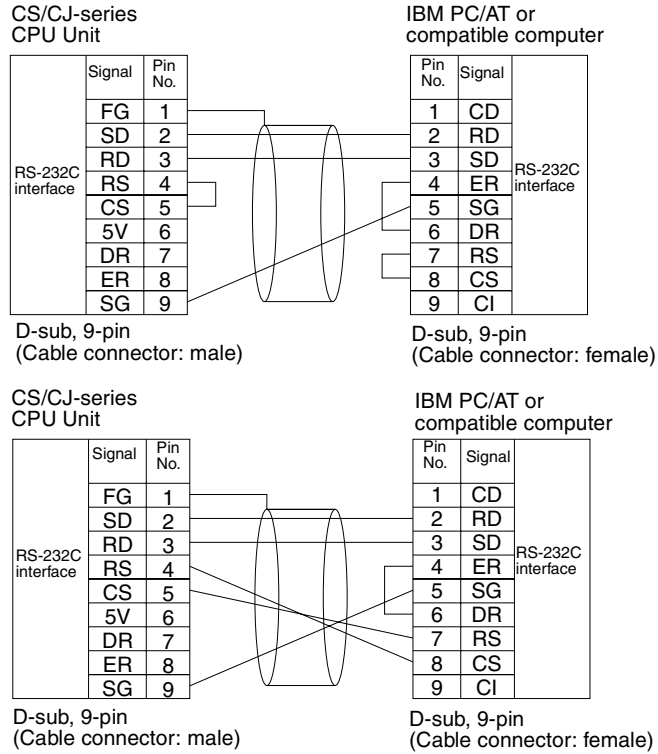

**Applicable Connectors**

Use the following connector at the CPU Unit end.

Product name	Model number	Specifications	
Plug	XM2A-0901	9-pin, male	Use together. (1 is provided with CPU Units as a standard accessory.)
Hood	XM2S-0911-E	For 9-pin, metric screws Anti-static	

Use the following connector at the computer end (IBM PC/AT or compatible).

Product name	Model number	Specifications	
Plug	XM2D-0901	9-pin, female	Use together.
Hood	XM2S-0913	For 9-pin, Imperial screws	

Connect to an IBM PC/AT compatible computer using the following configuration.

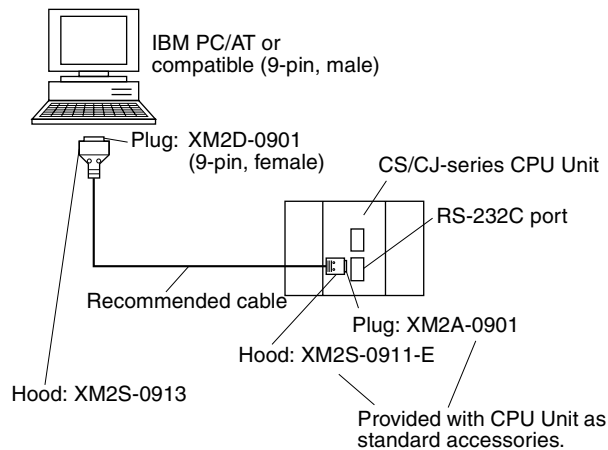

**Recommended Cables**

Fujikura Ltd.

UL2464 AWG28 × 5P IFS-RVV-SB (UL item)

AWG28 × 5P IFVV-SB (non-UL item)

Hitachi Cable, Ltd.

UL2464-SB (MA) 5P × 28AWG (7/0.127) (UL item)

CO-MA-VV-SB 5P × 28AWG (7/0.127) (non-UL item)

**2-2-2 Connecting to CP-series PLCs**

**Connecting to USB Port on CPU Unit with Commercially Available US Cable**

Unit	Port on Unit	Computer	Port on computer	Serial communications mode (network type)	Model number	Length	Remarks
CPU Unit	USB port (B connector)	IBM PC/AT compatible	USB port (A connector)	USB	Commercially available USB 1.1 or 2.0 cable	5 m max.	---

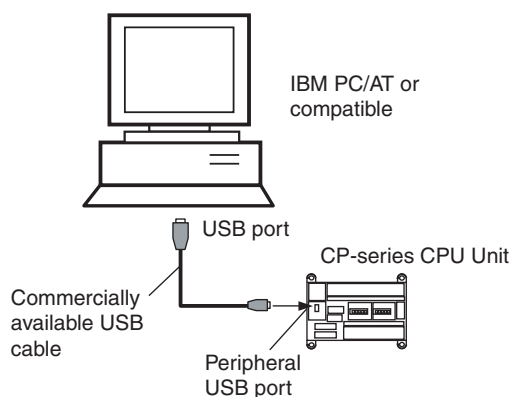

**Connecting to RS-232C Port on Serial Communications Board with RS-232C Cable**

Unit	Port on Unit	Computer	Port on computer	Serial communications mode (network type)	Model number	Length	Remarks
CP1W-CIF01 Serial Communications Board	RS-232C port, D-sub 9-pin female	IBM PC/AT compatible	D-sub, 9-pin, male	Toolbus (Peripheral) or SYSMAC WAY (Host Link)	XW2Z-200S-CV/500S-CV	2 m/5 m	Uses anti-static connector
				SYSMAC WAY (Host Link)	XW2Z-200S-V/500S-V	2 m/5 m	---

### 2-2-3 Connecting to CJ2 PLCs

#### USB or RS-232C Connection

Unit	Port on Unit	Computer	Port on computer	Serial communications mode (network type)	Model number	Length	Remarks
CPU Unit	USB port (B connector)	IBM PC/AT compatible	USB port (A connector)	USB	Commercially available USB 1.1 or 2.0 cable	5 m max.	---
	Built-in RS-232C port, D-sub 9-pin female	IBM PC/AT compatible	D-sub 9-pin, male	Toolbus (See note.)	XW2Z-200S-CV/500S-CV	2 m/5 m	Uses anti-static connector

**Note** A Host Link (SYSMAC WAY) connection to an RS-232C port on the CPU Unit or a Serial Communications Unit is not possible for CJ2 PLCs.

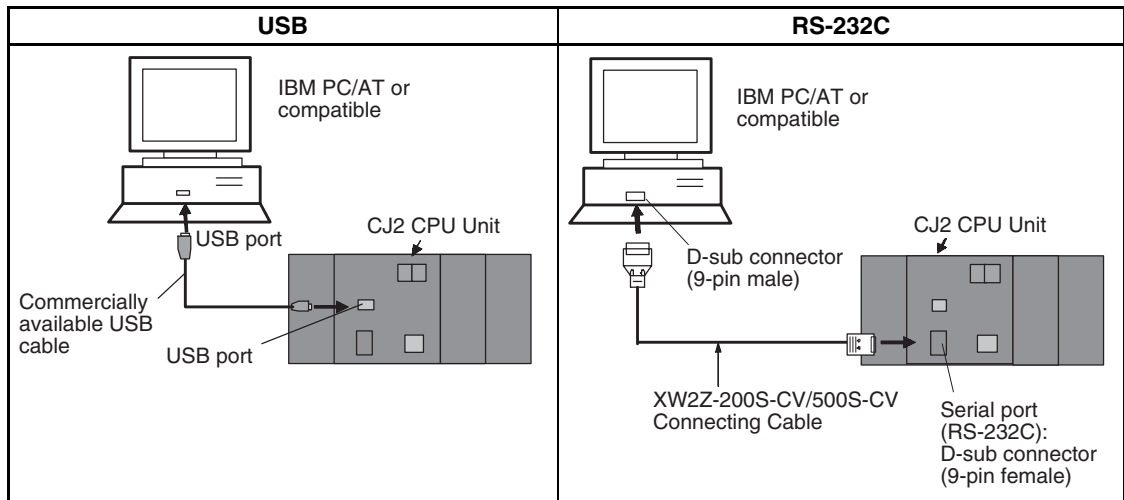

#### Ethernet Connection

Port on Unit	Port on computer	Serial communications mode (network type)	Model number	Length	Remarks
Built-in EtherNet/IP port	Ethernet port	100Base-TX/10Base-T (Recommended: 100Base-TX)	Commercially available twisted cable based on EtherNet/IP standard	100 m (between hub and node)	---
			Commercially available switching hub	---	

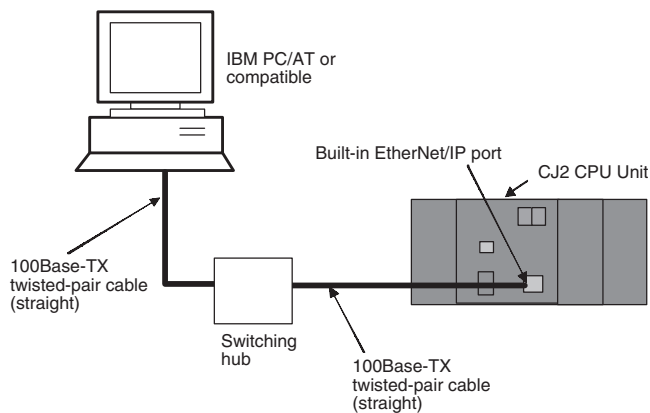

## 2-3 Basic Operations

Descriptions of CX-Position's basic operations are given below.

### 2-3-1 Starting

Select **Start - Program - OMRON - CX-One - CX-Position - CX-Position**. The application will be started and the following window will be displayed.

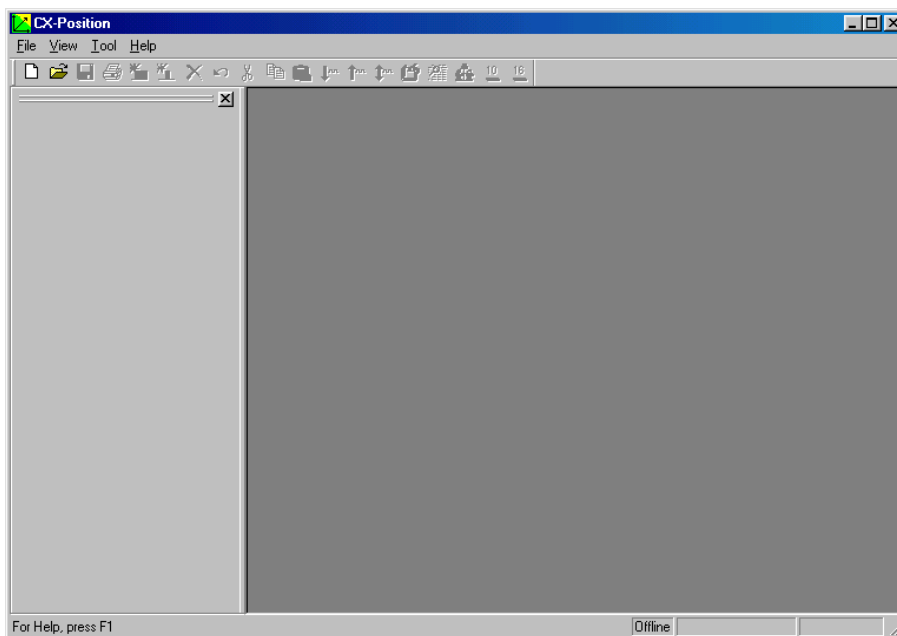

When the device type is set to a CS/CJ-series PLC or NSJ-series NSJ Controller, the CX-Position can also be started by right-clicking a Position Control Unit in the I/O Table Window opened from the CX-Programmer that was installed from the CX-One and selecting **Start Special Application** from **Start Only** is selected from the submenu, the CX-Position will be started in the same way as it is from the Windows Start Menu. If **Start with Settings Inherited** is selected from the submenu, the CX-Position will be started using the current device type setting, Position Control Unit model, and online/offline status. (Creating a new project and adding a PLC and Position Control Unit will also be performed automatically.)

### 2-3-2 Quitting

- 1,2,3...
1. Select **File - Exit** or click the Close Button at the top right corner of the window. After editing a project, if the project has not been saved, the following dialog box will be displayed.

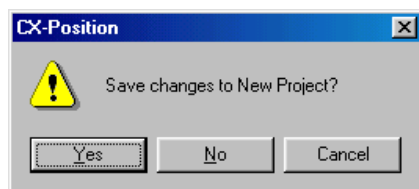

2. Click the **Yes** Button to save the changes made. Click the **No** Button if it is not necessary to save the changes. Click the **Cancel** Button to return to the Project Editing Window without quitting CX-Position. Refer to 5-1 Saving Projects.

### 2-3-3 Basic Window

CX-Position's Basic Window is shown below.

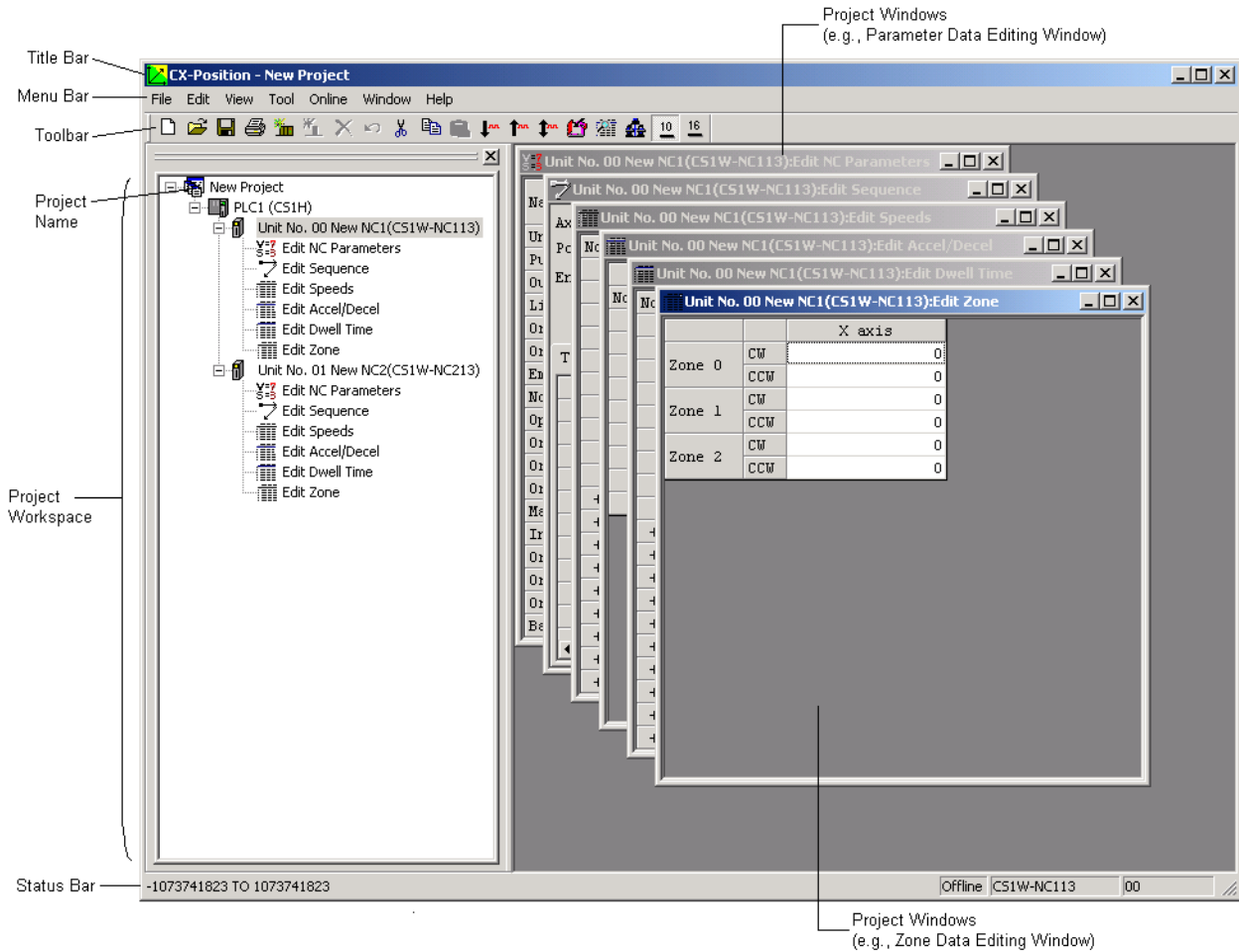

The Basic Window is split into 2 sections.

- The data hierarchy is displayed in tree format in the section on the left. This section is called the project workspace.
- The section on the right contains project windows, which are displayed when data icons in the project workspace are selected, when new data is created, and when online operations are performed.

The menus that can be used with CX-Position are displayed on the menu bar. The functions that can be used with CX-Position are displayed as icons on the toolbar.

## Windows

### Project Workspace

Data is displayed in the hierarchy shown below.

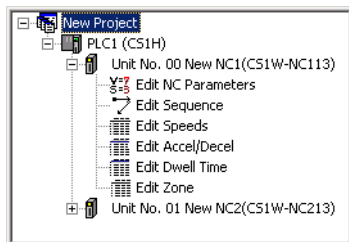

A Minus Icon appears next to data for which the lower level is displayed. A Plus Icon appears next to data for which the lower level is not displayed.

If there is more than one PLC or Position Control Unit, then the corresponding number of icons is displayed. One of each type of data file (e.g., parameters and speeds) is registered for each Position Control Unit.

The Plus and Minus Icons can be used to display/hide sub-hierarchies. The Plus Icon next to a data icon indicates that there is a hidden sub-hierarchy for that data. Click the **Plus** Icon to display the sub-hierarchy. The Minus Icon next to a data icon indicates that the sub-hierarchy for that data is displayed. Click the **Minus** Icon to hide the sub-hierarchy.

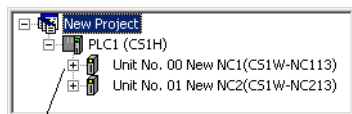

Click the Plus Icon.

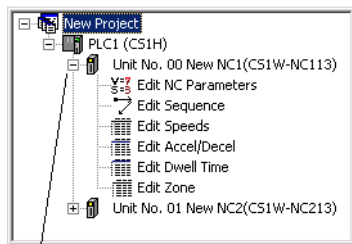

The Plus Icon changes to a Minus Icon and the sub-hierarchy is displayed.

The cursor can be moved up and down inside the project workspace when it is active using the **Up** and **Down** Keys. If the **Right** Key is pressed when the cursor is at a Plus Icon, the corresponding sub-hierarchy will be displayed. If the **Left** Key is pressed when the cursor is at a Minus Icon, the cursor will move to the next level up in the hierarchy.

### Project Windows

Project windows are displayed for data files selected from the project workspace by double-clicking, and for online operations, such as transferring data and monitoring Position Control Unit operation. The project workspace or project windows can be made active simply by click the required window. Project windows can also be made active by selecting **Window - Project** from the menu bar.

### 2-3-4 Displaying Menus

If, for example, you click **File**, or press the **Alt+F** Keys, a menu will be displayed. Select functions from the menu by click the desired item.

Example: The following menu is displayed if you click **File**.



<u>N</u> ew	Ctrl+N
<u>O</u> pen...	Ctrl+O
<u>C</u> lose Project	
<u>S</u> ave Project	Ctrl+S
Save Project <u>A</u> S	Ctrl+A
Close	
Import	
Export	
<u>P</u> rint	Ctrl+P
Properties	
<u>E</u> xit	
1 C:\My Documents\sample.nci	

Shortcut keys are allocated to some functions. These allocations are displayed on the right side of the menu. For example, **New** can be selected by pressing the **Ctrl+N** Keys (i.e., by pressing the **N** Key while holding down the **Ctrl** Key).

If the menu is displayed, **New** can also be selected by pressing the **N** Key (i.e., the underlined letter).

### 2-3-5 Moving and Copying Position Control Unit Data

Position Control Unit data, such as parameters, sequences, and speeds, can be moved to other Position Control Units in the same project in units of Position Control Units either using drag-and-drop or by using the **Cut** and **Paste** commands. Data can also be copied using the **Copy** and **Paste** commands.

## Moving Position Control Unit Data

Position Control Unit data can be moved between CPU Units of the same series. The following example shows how to move the data for NC2 on PLC1 to PLC2.

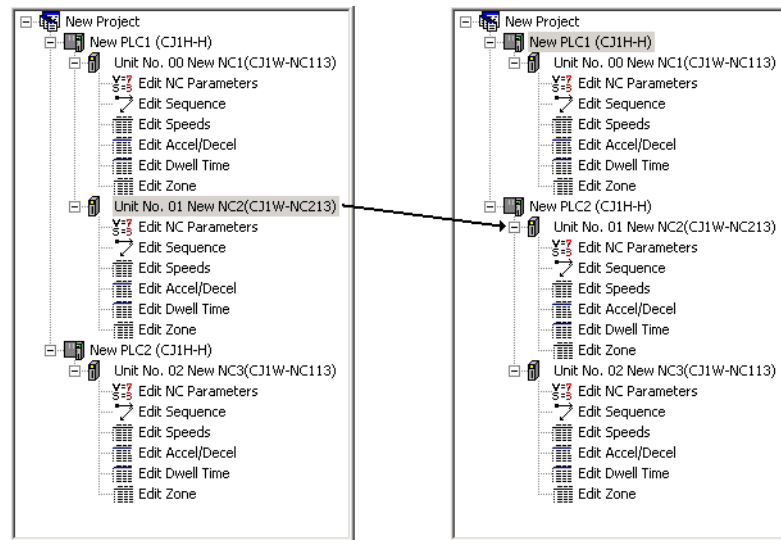

Either of the following 2 methods can be used.

### ■ Drag and Drop

- 1,2,3...**
1. Click the **NC2** Icon, and move the cursor across to PLC 2 with the (left) mouse button held down. When the Position Control Unit Icon appears, release the mouse button.

The Position Control Unit Icon appears only if the data can be moved. If the data cannot be moved, the Operation Prohibited Icon will be displayed.

### ■ Cut and Paste

- 1,2,3...**
1. Select the **NC2** Icon and execute the **Cut** command using any of the following methods:
    - Right-click and select **Cut** from the pop-up menu.
    - Select **Edit - Cut** from the menu bar.
    - Click the **Cut** Icon in the toolbar.
  2. Select the **PLC2** Icon and paste the data using any of the following methods:
    - Right-click and select **Paste** from the pop-up menu.
    - Select **Edit - Paste** from the menu bar.
    - Click the **Paste** Icon in the toolbar.



If there is a Position Control Unit with the same unit number at the PLC to which NC2 is copied, the following dialog box will be displayed. Set a new unit number (i.e., a unit number that is not used at that PLC). Changing this setting will change the unit number of the Position Control Unit itself. The following dialog box indicates that the unit number of NC2 is already used for another Position Control Unit.

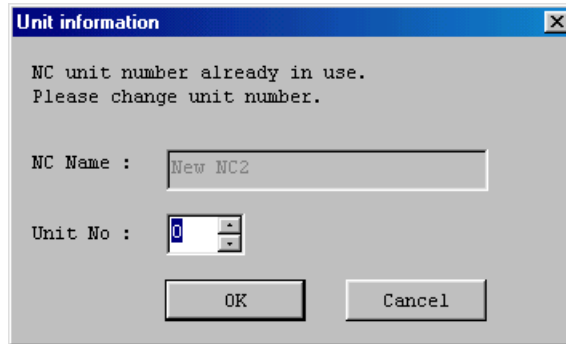

### Copying Position Control Unit Data

When data is copied from one Position Control Unit to another, the data at the destination Position Control Unit is overwritten.

Position Control Unit data can be copied between CPU Units of the same series.

If data is copied to a Position Control Unit that controls a higher number of axes, only the data corresponding to the axes controlled by the source Position Control Unit is overwritten.

1,2,3...

1. Select the icon of the source Position Control Unit.
2. Copy the data using any of the following methods:
  - Right-click and select **Copy** from the pop-up menu.
  - Press the **Ctrl+C** Keys.
  - Select **Edit - Copy** from the menu bar.
  - Click the **Copy** Icon in the toolbar.
3. Select the icon of the destination Position Control Unit and paste the data using any of the following methods:
  - Right-click and select **Paste** from the pop-up menu.
  - Press the **Ctrl+V** Keys.
  - Select **Edit - Paste** from the menu bar.
  - Click the **Paste** Icon in the toolbar.

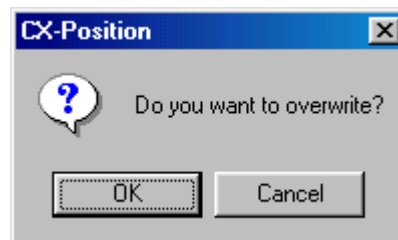

4. Click the **OK** Button.

**2-3-6 Main Menus**

Main menu	Contents	Keyboard shortcut
File	Used to create, save, and print new projects.	Alt+F
Edit	Used to add or remove PLCs and Position Control Units to/from projects, and edit Position Control Unit data.	Alt+E
View	Used to display or hide project trees, the toolbar, and the scroll bar, and to switch between decimal and hexadecimal display of Position Control Unit data.	Alt+V
Tool	Used to make optional settings (font, number of files displayed on the recently used file list, default display format (decimal/hexadecimal)).	Alt+T
Online	Used for performing online operations, such as downloading, uploading, comparison, and monitoring.	Alt+L
Window	Used to change the display method for the currently displayed editing window. It is also used to move the focus from the data editing window to the project tree.	Alt+W
Help	Used to display help and version information and to perform online user registration.	Alt+H

## 2-3-7 Main Menu Items











The names and functions for all of the menus are given in the following table. When an item is selected, the dialog box for that function is displayed. Follow the instructions in the dialog box.







Main menu	Item	Contents	Keyboard shortcut
File	New	Creates a new project file.	Ctrl+N
	Open	Opens an existing project file.	Ctrl+O
	Close Project	Closes the active project.	---
	Close	Closes the active data editing window.	---
	Save Project	Saves the active project (overwrites the previous data).	Ctrl+S
	Save Project As	Saves the active project with a new name.	Ctrl+A
	Import	Imports data created for the C200HW-NC□13 with the SYSMAC-NT.	---
	Print	Prints all Position Control Unit data or specified data.	Ctrl+P
	Properties	Displays the properties for a project, PLC, or Position Control Unit.	---
	Exit	Quits CX-Position.	---
Edit	New PLC	Creates a new PLC for a project.	---
	New NC	Creates a new Position Control Unit for a PLC.	---
	Remove	Removes a specified PLC or Position Control Unit from a project.	Del
	Undo	Undoes the previous operation.	Ctrl+Z
	Cut	<ul style="list-style-type: none"> <li>Used to move a specified Position Control Unit in the project tree to another PLC.</li> <li>Used to move data in specified range (other than parameter editing windows).</li> </ul>	Ctrl+X
	Copy	<ul style="list-style-type: none"> <li>Used to copy data from a specified Position Control Unit in the project tree to another PLC's Position Control Unit.</li> <li>Used to copy specified data in a data editing window.</li> </ul>	Ctrl+C
	Paste	Copies the data copied to the clipboard using <b>Cut</b> or <b>Copy</b> to a specified position.	Ctrl+V
	Display All	Displays all the data editing windows to a specified Position Control Unit. If there are already windows displayed, the remaining windows are displayed. Up to 90 windows can open at the same time. This command cannot be used if there are 90 or more windows open.	---
	Default Clear/Clear	<ul style="list-style-type: none"> <li>The command <b>Default Clear</b> is displayed in parameter editing windows. It returns the parameter settings for a specified axis to their default values.</li> <li>The command <b>Clear</b> is displayed in other windows. This command clears specified data to 0.</li> </ul>	---
	Copy Axis	Copies data in axis units.	---

Main menu	Item	Contents	Keyboard shortcut	
View	Project	Displays/hides project tree.	---	
	Toolbar	Displays/hides toolbar.	---	
	Status Bar	Displays/hides status bar.	---	
	Change Display	Hexa-decimal	Changes the display format for the active data editing window and the input range display for the status bar to hexa-decimal.	---
		Decimal	Changes the display format for the active data editing window and the input range display for the status bar to decimal.	---
Tool	Option	Displays the option dialog box. Used to perform the following settings. <ul style="list-style-type: none"> <li>• Font name and size</li> <li>• Default display format (decimal/hexa-decimal) for data editing windows</li> <li>• Number of files displayed on the recently used files list (16 max.)</li> </ul>	---	
Online	Download to NC	Transfers specified data or all data to a specified Position Control Unit.	---	
	Upload from NC	Transfers specified data or all data from a specified Position Control Unit to a project.	---	
	Verify	Compares editing data with the data of a specified Position Control Unit.	---	
	Write Flash Memory	Writes Position Control Unit data to flash memory.	---	
	Monitor	Monitors Position Control Unit operating status.	---	
	Monitor Units	Simultaneously monitors the operating status for 4 Position Control Units.	---	
	Automatic NC Search	Reads information about the Position Control Units mounted to the PLC connected online, and automatically creates a project based on this information. If the <i>Upload Data</i> checkbox is selected, all data for the Position Control Units mounted to the specified PLC is read and included in the project.	---	
	Monitor NC Operating Memory Area	Monitors the commands, Position Control Unit status, I/O status, and error codes allocated to the operating memory area.	---	
	Monitor NC Operating Data Area	Monitors the positions, speeds, acceleration/deceleration times, sequence numbers, and present positions specified in the operating data area.	---	
	View NC Error Log	Displays the error log for a specified Position Control Unit.	---	
	Test Run	Executes JOG operations.	---	
	Test Run Settings	Sets values to execute JOG operations.	---	
	Error Counter Reset Output	Turns ON/OFF the error counter reset output signal.	---	

Main menu	Item	Contents	Keyboard shortcut
Window	Display All	Displays all the data editing windows that are represented as icons.	---
	Icon All	Displays all data editing windows as icons.	---
	Cascade	Displays editing windows on top of each other.	---
	Tile Horizontally	Displays editing windows arranged horizontally.	---
	Tile Vertically	Displays editing windows arranged vertically.	---
	Arrange Icons	Aligns editing windows represented as icons.	---
	Close All	Closes all open editing windows.	---
	Project	Moves the focus to the project tree.	---
Help	Contents	Displays the table of contents for help.	---
	Search	Displays the search window for help.	---
	Unit Error	Displays help for Unit errors.	---
	Online Registration	Connects to the CX-One website for online software registration.	---
	Version	Displays the version information for CX-Position.	---

## 2-3-8 Operations Listed by Purpose

Purpose		Operation	Keyboard shortcut	Toolbar icon	Reference section
Project	Creating a new project	<b>File – New</b>	Ctrl+N		3-1
	Opening a project	<b>File – Open</b>	Ctrl+O		5-2-1
	Closing a project	<b>File – Close Project</b>	---	---	2-3-2
	Saving (overwriting)	<b>File – Save Project</b>	Ctrl+S		5-1-1
	Saving with a different name	<b>File – Save Project As</b>	Ctrl+A	---	5-1-1
	Importing	<b>File – Import</b>	---	---	5-2-2
	Printing	<b>File – Print</b>	Ctrl+P		10-1
	Creating a new PLC	<b>Edit – New PLC</b> or Right-click and select <b>New PLC</b> .	---		3-2-1
	Creating a new Position Control Unit	Select a PLC and select <b>Edit - New NC</b> . or Select a PLC, right-click, and select <b>New NC</b> .	---		3-3-1
	Displaying the properties for a project, PLC, or Position Control Unit	Select a PLC or Position Control Unit and select <b>File – Properties</b> . or Select a PLC, right-click and select <b>Properties</b> .	---	---	3-1
	Removing a PLC or Position Control Unit	Select a PLC or Position Control Unit and select <b>Edit – Remove</b> . or Select a PLC or Position Control Unit, right-click, and select <b>Remove</b> .	DEL		3-2-2, 3-3-2
	Cutting a Position Control Unit	Select a Position Control Unit and select <b>Edit – Cut</b> . or Select a Position Control Unit, right-click, and select <b>Cut</b> .	Ctrl+X		2-3-5
	Copying Position Control Unit data	Select a Position Control Unit and select <b>Edit – Copy</b> .	Ctrl+C		2-3-5
	Pasting a Position Control Unit	Select a PLC and select <b>Edit – Paste</b> . or Select a PLC, right-click, and select <b>Paste</b> .	Ctrl+V		2-3-5
	Pasting Position Control Unit data	Select a Position Control Unit and select <b>Edit – Paste</b> . or Select a Position Control Unit, right-click, and select <b>Paste</b> .	Ctrl+V		2-3-5
Moving Position Control Unit data	Drag the Position Control Unit using the mouse and drop it at the desired PLC.	---	---	2-3-5	

Purpose		Operation	Keyboard shortcut	Toolbar icon	Reference section
Display settings	Displaying/hiding a project	<b>View – Project</b>	---	---	2-3-12
	Displaying/hiding the toolbar	<b>View – Toolbar</b>	---	---	2-3-12
	Displaying/hiding the status bar	<b>View – Status Bar</b>	---	---	2-3-12
	Switching between decimal and hexadecimal display	<ul style="list-style-type: none"> <li>• <b>View – Change Display – Decimal</b> or <b>Hexadecimal</b></li> <li>• Right-click in editing window and select <b>Decimal</b> or <b>Hexadecimal</b></li> </ul>	---	 	2-3-12, 4-2-3
	Opening all editing windows	<ul style="list-style-type: none"> <li>• Select a Position Control Unit in the project and select <b>Edit – Display All</b></li> <li>• Select a Position Control Unit in the project, right-click and select <b>Display All</b></li> <li>• While data editing, select <b>Edit – Display All</b></li> </ul>	---	---	4-2-1
Editing data	Editing parameter data	<ul style="list-style-type: none"> <li>• Select <b>Edit NC Parameters</b> in the project and double-click.</li> <li>• Select <b>Edit NC Parameters</b> in the project and click the <b>Enter</b> Button.</li> </ul>	---	---	4-3-2
	Editing sequence data	<ul style="list-style-type: none"> <li>• Select <b>Edit Sequence</b> in the project and double-click.</li> <li>• Select <b>Edit Sequence</b> in the project and click the <b>Enter</b> Button.</li> </ul>	---	---	4-4
	Editing speed data	<ul style="list-style-type: none"> <li>• Select <b>Edit Speeds</b> in the project and double-click.</li> <li>• Select <b>Edit Speeds</b> in the project and press <b>Enter</b>.</li> </ul>	---	---	4-5
	Editing acceleration/deceleration data	<ul style="list-style-type: none"> <li>• Select <b>Edit Accel/Decel</b> in the project and double-click.</li> <li>• Select <b>Edit Accel/Decel</b> in the project and click the <b>Enter</b> Button.</li> </ul>	---	---	4-6
	Editing dwell time data	<ul style="list-style-type: none"> <li>• Select <b>Edit Dwell Time</b> in the project and double-click.</li> <li>• Select <b>Edit Dwell Time</b> in the project and click the <b>Enter</b> Button.</li> </ul>	---	---	4-7
	Editing zone data	<ul style="list-style-type: none"> <li>• Select <b>Edit Zone</b> in the project and double-click.</li> <li>• Select <b>Edit Zone</b> in the project and click the <b>Enter</b> Button.</li> </ul>	---	---	4-8
	Initializing the data in a specified range	<b>Edit – Cut</b>	Ctrl+X		---
	Copying the data in a specified range	<b>Edit – Copy</b>	Ctrl+C		---
	Pasting the data in a specified range	<b>Edit – Paste</b>	Ctrl+V		---
	Undoing the last operation	<b>Edit – Undo</b>	Ctrl+Z		---
	Returning parameter data to default settings	<b>Edit – Default Clear</b> or In an editing window, right-click and select <b>Default Clear</b> . (Parameter editing windows only)	---	---	4-2-4

Purpose		Operation	Keyboard shortcut	Toolbar icon	Reference section
Editing data	Clearing data in a specified range to 0	<b>Edit – Clear</b> or In an editing window, right-click and select <b>Clear</b> (Windows other than parameter editing windows)	---	---	4-2-4
	Copying data to another axis	<b>Edit – Copy Axis</b>	---	---	4-2-5
Online operations	Downloading	<b>Online – Download to NC</b>	---		6-3
	Uploading	<b>Online – Upload from NC</b>	---		6-4
	Verification	<b>Online – Verify</b>	---		6-5
	Writing to flash memory	<b>Online – Write Flash Memory</b>	---		6-6
	Monitoring a Position Control Unit	<b>Online – Monitor</b>	---		10-1
	Monitor Units	<b>Online – Monitor Units</b>	---		7-2
	Automatic setting of project	<b>Online – Automatic NC Search</b>	---	---	6-4-2
	Monitoring operating memory area	<b>Online – Monitor NC Operating Memory Area</b>	---	---	7-3
	Monitoring operating data area	<b>Online – Monitor NC Operating Memory Area</b>	---	---	7-4
	Displaying an error log	<b>Online – View NC Error Log</b>	---	---	11-1-2
	Test Run	<b>Online – Test Run</b>	---	---	8-2
	Test Run Settings	<b>Online – Test Run Settings</b>	---	---	8-1
	Error Counter Reset Output	<b>Online – Error Counter Reset Output</b>	---	---	9-1
Option settings	Making font settings	<b>Tool – Option – Font</b>	---	---	2-3-11
	Setting the default display format	<b>Tool – Option – Default Display Format</b>	---	---	2-3-11
	Setting the number of files displayed in the recently used files list	<b>Tool – Option – Number of recent used files</b>	---	---	2-3-11
Displaying help	Displaying help table of contents	<b>Help – Contents</b>	---	---	2-3-13
	Searching for help topics	<b>Help – Search</b>	---	---	2-3-13
	Displaying help for Unit errors	<b>Help – Unit Error</b>	---	---	2-3-13
	Registering online	<b>Help – Online Registration</b>	---	---	2-3-13
	Displaying CX-Position version information	<b>Help – Version</b>	---	---	2-3-13



### 2-3-9 Toolbar

Functions can be executed directly by click the appropriate icon on the toolbar. The functions that can be executed from the toolbar are given below.

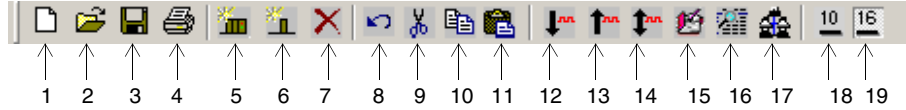

Number	Function	Number	Function
1	Creates a new project.	11	Inserts the clipboard contents at the insertion point.
2	Opens an existing project.	12	Download
3	Saves the active project.	13	Upload
4	Print	14	Verify
5	Adds a new PLC.	15	Writes to flash memory
6	Adds a new Position Control Unit.	16	Monitors Position Control Unit operating status.
7	Delete	17	Monitors operating status for 4 Position Control Units.
8	Undo	18	Changes display format to decimal.
9	Cuts the selection and moves it to the clipboard.	19	Changes display format to hexadecimal.
10	Copies the selection and moves it to the clipboard.		

### 2-3-10 Status Bar

The following information is displayed on the status bar.



- Network information or Position Control Unit's unit No.
- PLC or Position Control Unit model
- Communications mode (offline/online)
- When inputting data, the range that can be input is displayed here. Help is displayed at other times.

## 2-3-11 Option Settings

The following settings can be made as option settings.

- Name and size of font for data editing windows
- Default display format for data editing windows
- Number of files displayed in the recently used files list

### Setting the Font Name and Size

- 1,2,3... 1. Select **Tool - Option**. The Option Dialog Box is displayed.

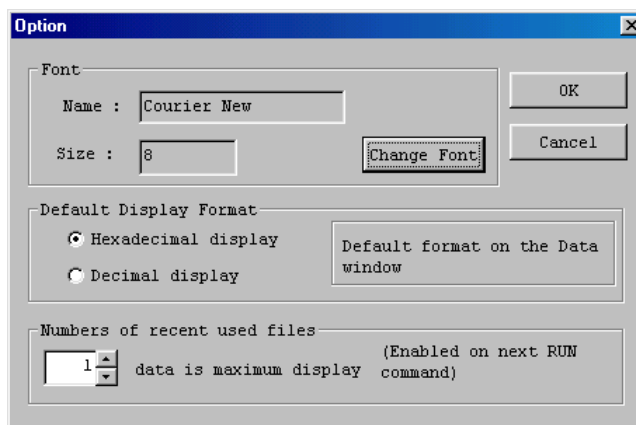

2. Click the **Change Font** Button. The Change Font Dialog Box will be displayed.

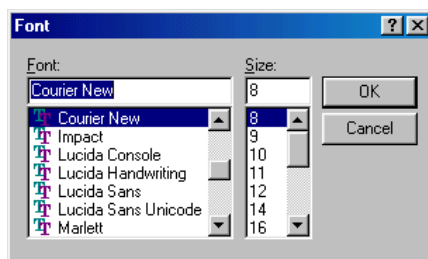

3. After selecting the desired font name and size from the drop-down lists, click the **OK** Button.

### Setting the Default (Startup) Display Format

- 1,2,3... 1. Select **Tool - Option**. The Option Dialog Box will be displayed.
2. Under **Default Display Format**, select either **Hexadecimal display** or **Decimal display**.

### Setting the Number of Files Displayed in the Recently Used Files List

- 1,2,3... 1. Select **Tool - Option**. The Option Dialog Box will be displayed.
2. Under **Numbers of recent used files**, either enter a number directly or select a number from the drop-down list.

## 2-3-12 View Settings

The view settings can be used to display or hide the project tree, the toolbar, or the status bar, or change the display format (decimal/hexadecimal) for the active data editing window.

### Display/Hide Settings

1,2,3...

1. Click **View**.

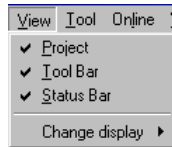

2. If a check appears next to **Project**, **Toolbar**, or **Status Bar**, the corresponding item is displayed. To hide any of these, select **Project**, **Toolbar**, or **Status Bar** to remove the check.

### Setting the Display Format

Data in the active data editing window can be displayed in either decimal or hexadecimal. The default display format is set in the option settings.

1,2,3...

1. Select the data for which the display format is to be changed, and either right-click or select **View - Change display**.



2. Select either **Hexadecimal** or **Decimal** as desired.

#### Note

1. The display format can also be changed by right-clicking in the editing window, and selecting either **Decimal** or **Hexadecimal** from the pop-up menu.
2. Hexadecimal cannot be used if the unit setting is either millimeter or inch. Use decimal display.

## 2-3-13 Help

### Displaying the Help Contents

1,2,3...

1. Select **Help - Contents**. The table of contents for help will be displayed.

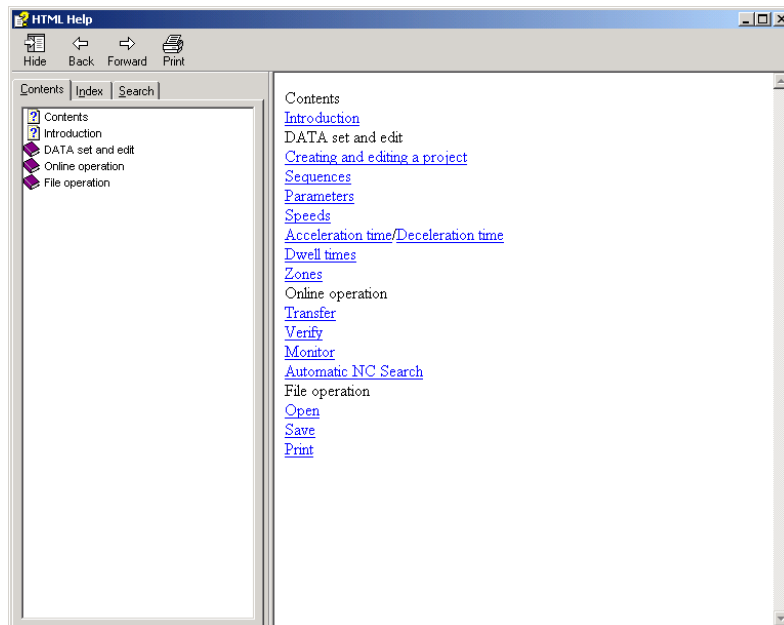

2. Select an item to display information relating to that item.

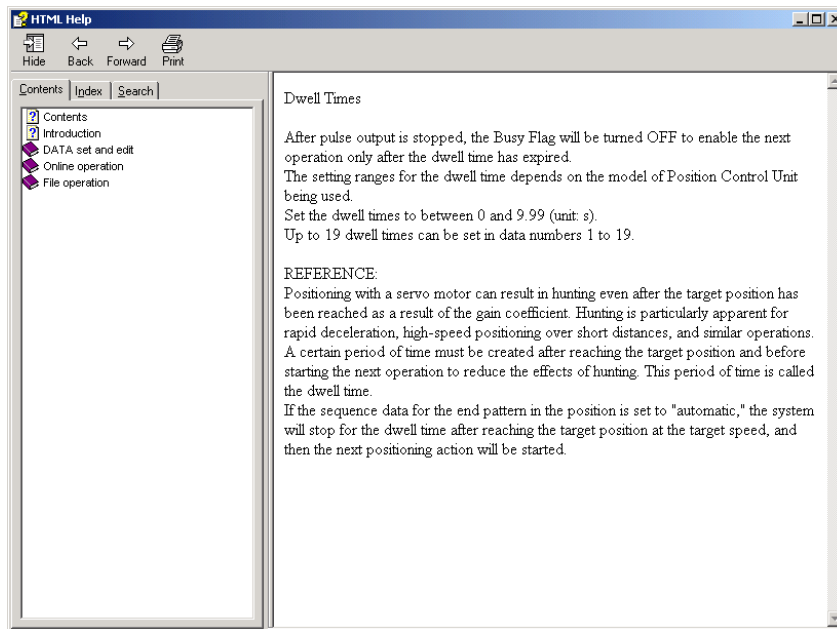

**Searching by Key Word**

1,2,3...

1. Select **Help - Search**. The Help Topics Dialog Box will be displayed.

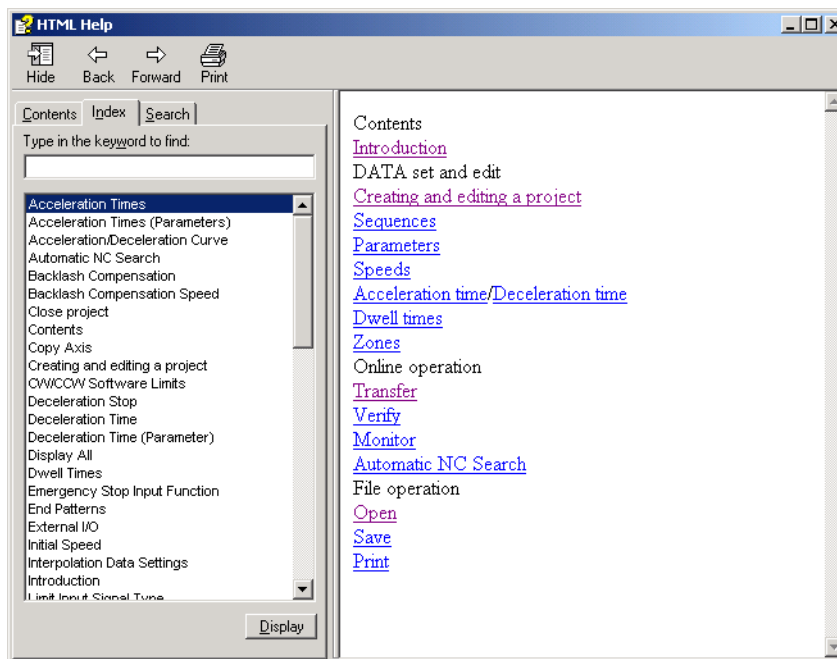

2. Enter the first few letters of the word to be searched for and press **Enter** or click the **Display** Button. If a matching word is found, it is highlighted. Select **Display** or double-click to display the information for that word.

It is also possible to click directly on a key word (index entry) and then click the **Display** Button or double-click to display the information for that word.

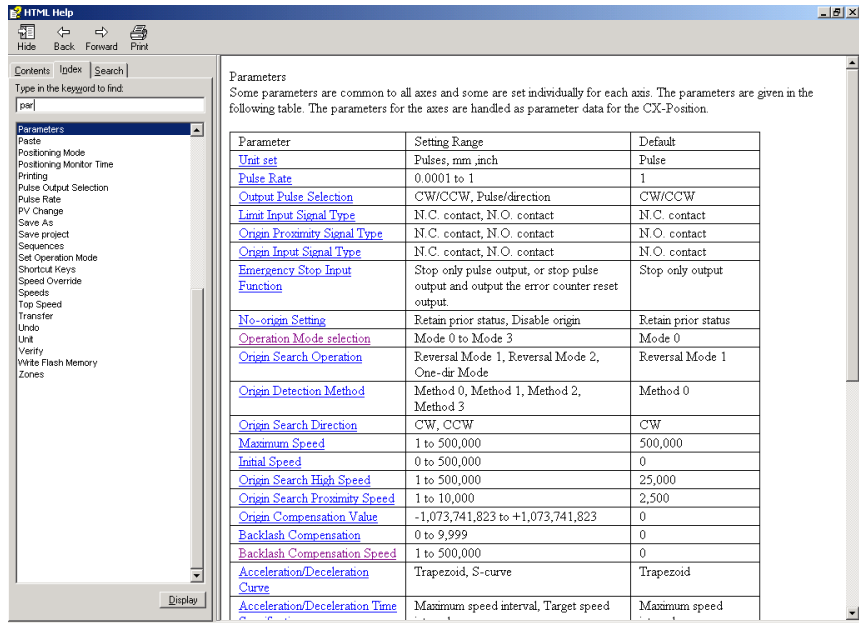

**Displaying Unit Errors**

Use the following procedure to display help for Position Control Unit errors.

1,2,3...

1. Select **Help - Unit Error**. The Error Code Help Dialog Box will be displayed.

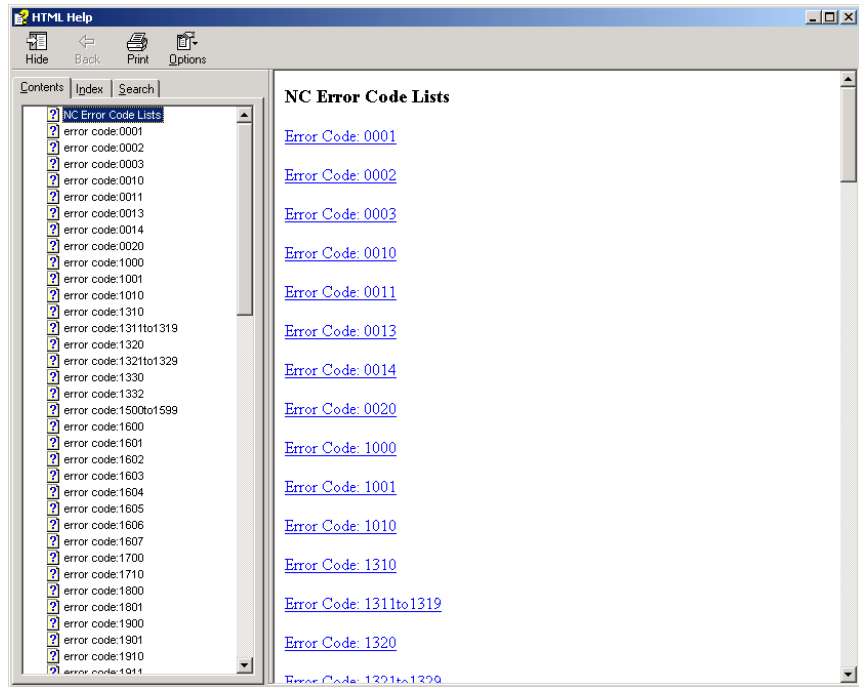

- Click the relevant error code. Information about that error code will be displayed.

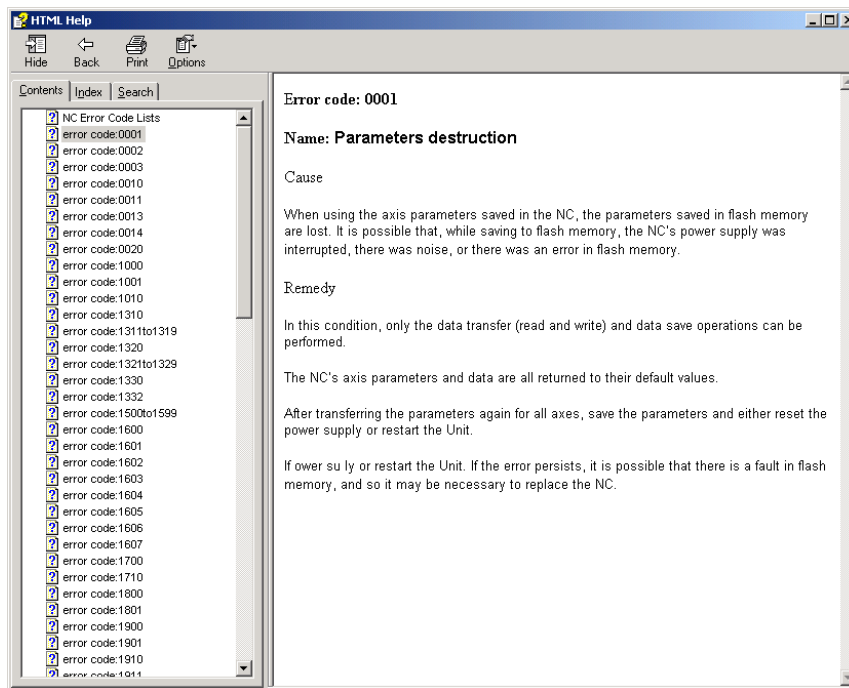

**Registering CX-Position Online**

- 1,2,3...
- Select **Help - Online Registration**. The OMRON CX-One website will be displayed.
  - Enter user information as directed on the screen.

**Note** The Product Key and Licence Number listed in the Licence Agreement will be required for online user registration.

**Displaying CX-Position Version Information**

Select **Help - Version**. The CX-Position version information will be displayed.



# SECTION 3

## Creating New Projects

This section describes the procedures for creating new projects, as well as those for adding and deleting Programmable Controllers (PLCs) and Position Control Units (NC Units).

- 3-1 Creating New Projects . . . . . 38
- 3-2 Adding and Deleting PLCs . . . . . 40
  - 3-2-1 Adding a PLC . . . . . 40
  - 3-2-2 Deleting a PLC . . . . . 43
- 3-3 Adding and Deleting Position Control Units . . . . . 44
  - 3-3-1 Adding a Position Control Unit . . . . . 44
  - 3-3-2 Deleting a Position Control Unit . . . . . 44
- 3-4 Automatic Position Control Unit Search . . . . . 45



### 3-1 Creating New Projects

Starting CX-Position from the Windows Start Menu, or by Selecting *Start Special Application - Start Only* from the Pop-up Menu in I/O Table Window Opened from the CX-Programmer That Was Installed from the CX-One

Use the following procedure to create a new project.

- 1,2,3... 1. Select **File - New**, press the **Ctrl+N** Keys, or select the *New Project* Icon from the toolbar.

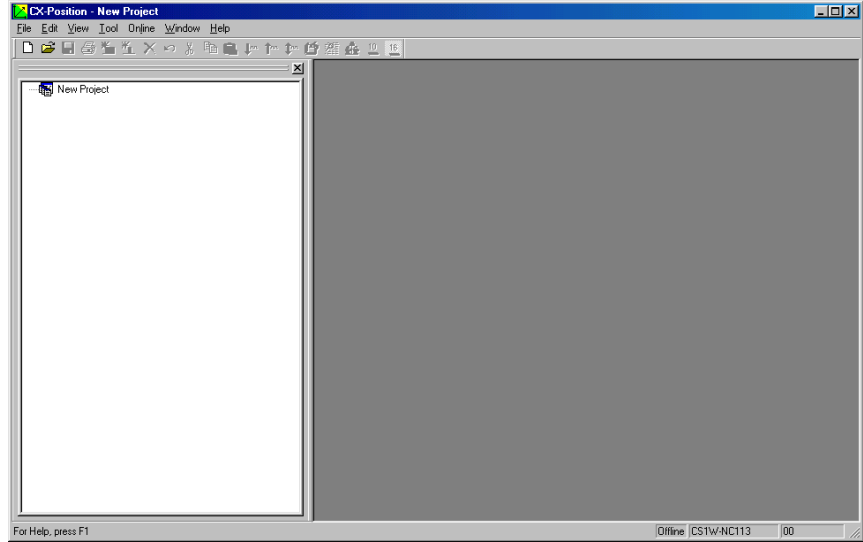

2. To change the project name, highlight the project and either select **File - Properties**, or right-click and select **Properties** from the pop-up menu.

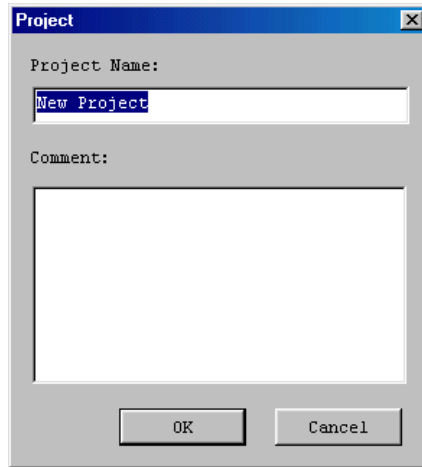

*New Project* is the default project name.

3. Enter the project name and click the **OK** Button. Comments can also be entered.

**Starting CX-Position by Selecting *Start Special Application - Start with Settings Inherited* from the Pop-up Menu in I/O Table Window Opened from the CX-Programmer That Was Installed from the CX-One**

- 1,2,3... 1. Right-click a Position Control Unit in the I/O Table Window and select **Start Special Application - Start with Settings Inherited** from the popup menu.

Example: Right-click the Position Control Unit (e.g., CJ1W-NC133)

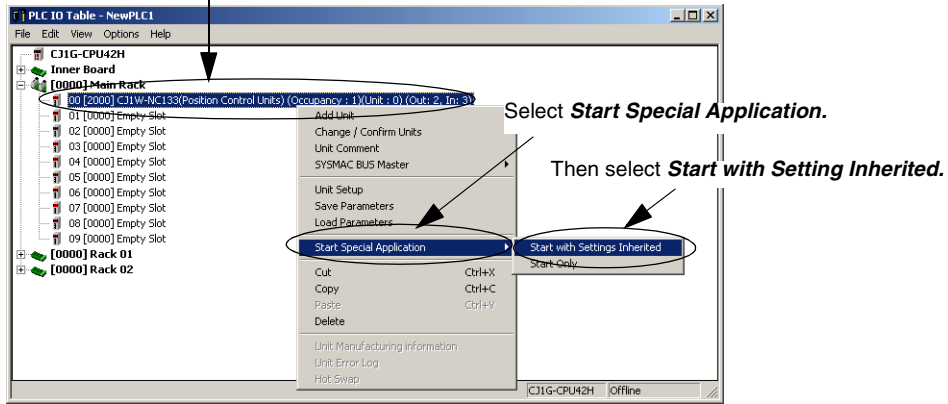

2. The CX-Position will be started, a new project will be created, and a Position Control Unit will be added automatically. The PLC information, Position Control Unit model, and unit number will be inherited as shown below.

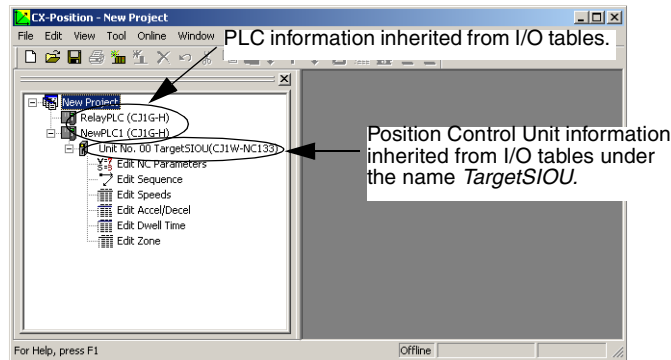

**Note** Even if there is more than one Position Control Unit in the I/O tables, information can be inherited by the CX-Position from only one of them.

## 3-2 Adding and Deleting PLCs

### 3-2-1 Adding a PLC

Use the following procedure to add a PLC to a new or existing project.

- 1,2,3... 1. Select the project from the project tree, and either select **Edit - New PLC** or right-click and select **New PLC** from the pop-up menu. The *Add PLC* Dialog Box will be displayed.

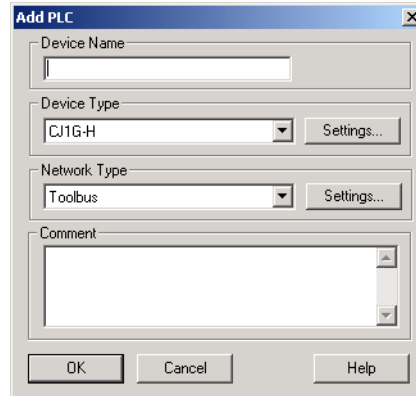

2. Enter the *Device Name*.

**Note** Use one-byte characters for the device name, except for the ones listed below and blank characters.

! " # \$ % & ' ( ) = - ~ ^ ¥ | ' @ { [ + ; \* : ] } < , > . ? /  
If [ or ] is used in the device name for PLCs functioning as gateways, the network address for the PLC on the gateway network will be 0. This will prevent communications with Position Control Units on the gateway network.

3. Set the *PLC Device Type* by click the *PLC Device Type* drop-down list and selecting the device type.
4. Click the **Settings** Button on the right of the *Device Type* box. The *Device Type Setup* Dialog Box will be displayed. Click the *CPU Type* drop-down list, select an applicable CPU type from the list, and click **OK**.



5. Set the network type. Select either SYSMC WAY (Host Link) or Toolbus.
6. Enter a comment if required.
7. Click the **Settings** Button on the right of *Network Type Selection* box.

### ■ When SYSMAC WAY (Host Link) Has Been Selected

The following Network Settings Dialog Box will be displayed as shown.

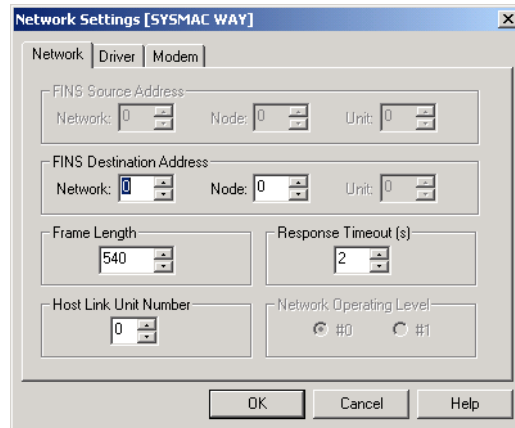

#### **Setting the Network Tab Page**

##### **FINS Remote Address**

This setting is required when going online with Position Control Unit mounted on a PLC in the network. Use the default setting (Network: 0, Node: 0). For the setting to go online with the PLC in the network, refer to *6-2-2 Connecting to PLCs on Networks*.

##### **Frame Length**

Use the default setting. When using 2 or more types of networks, use the shorter frame length among them.

##### **Response Timeout (s)**

When timeouts occur in online operations, increase the value set for response timeout (s).

#### **Note**

- The response timeout can be set to between 1 s and 600 s. When a value exceeding the range is set, it will be automatically adjusted so that it is within the range.
- Setting a response timeout shorter than 10 s may cause timeouts.
- Although the response timeout can be set to up to 600 s, online operations (monitoring, device info, etc.) cannot be canceled once started. Therefore, when setting a larger value for the response timeout, make sure that it will not cause any problems even without operations from the CX-Position.

##### **Host Link Unit No.**

Set the unit number of the Host Link port connected to the port on the computer. When the unit number of the Host Link port has been changed, set the applicable number.

**Setting the Driver Tab Page**

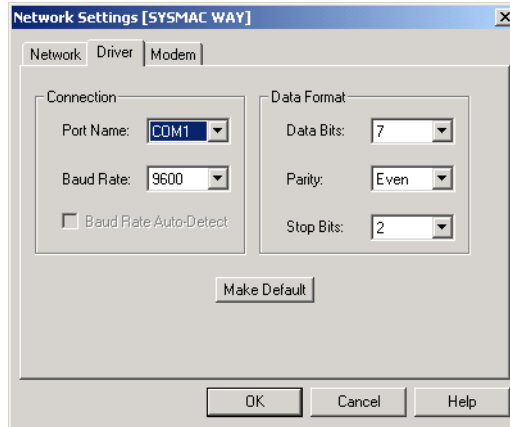

Set the **Connection** and **Data Format**. The communications settings here have to be the same as in the PLC Setup on CPU Unit. For details, refer to the operation manual of the CPU Unit being used.

The Modem Tab Page is used for the modem connection settings. The CX-Position can be connected to PLCs through a modem. For details on modem connections, refer to the *CX-Programmer Ver. 5.0 Operation Manual (W437)* and *CX-Programmer Ver. 6.1 Operation Manual (W446)*.

■ **When Toolbus Has Been Selected**

**Setting the Network Tab Page**

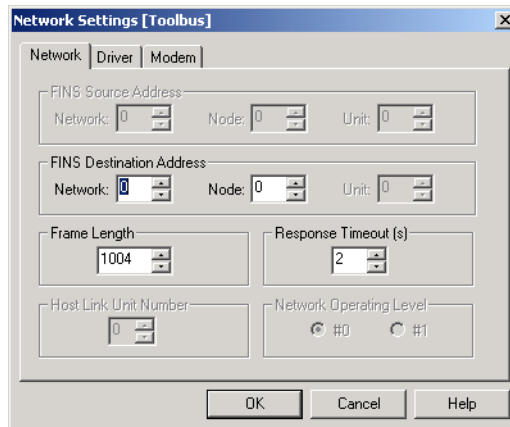

For various settings, see *When SYSMAC WAY (Host Link) Has Been Selected* for reference.

### Setting the Driver Tab Page

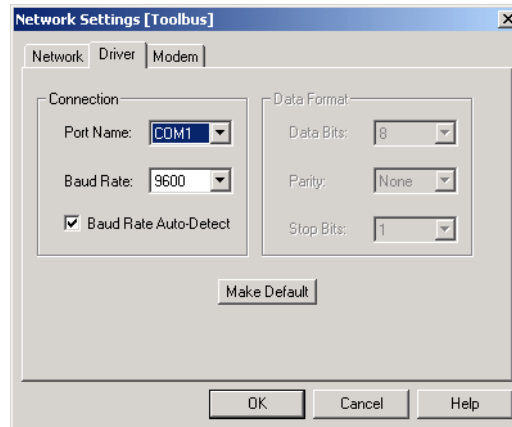

Baud rate auto-detect can be enabled here, communications are established with the baud rate set here regardless of the communications setting on the CPU Unit.

8. Click the **OK** Button to add the PLC to the project.

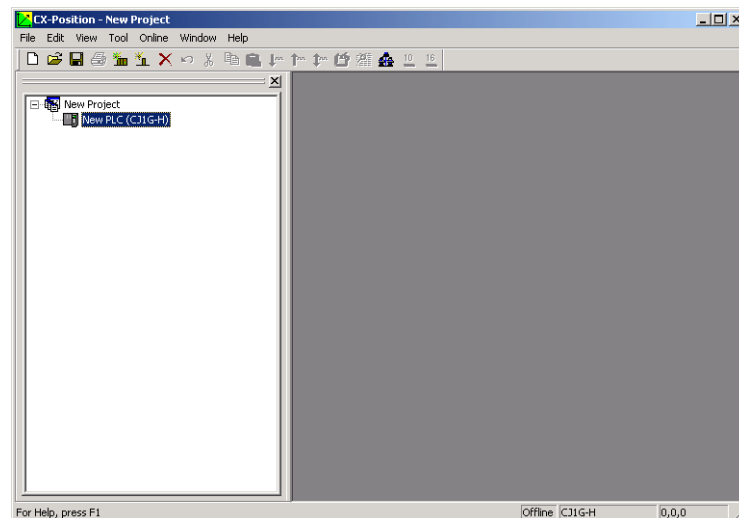

### 3-2-2 Deleting a PLC

- 1,2,3... 1. Select the PLC to be deleted from the project tree, and select **Edit - Remove DEL**, press the **DEL** Key, or right-click and select **Remove - DEL** from the pop-up menu.
2. A dialog box will be displayed asking "Do you want to delete?" Click the **OK** Button.

## 3-3 Adding and Deleting Position Control Units

### 3-3-1 Adding a Position Control Unit

Use the following procedure to add a Position Control Unit to a PLC.

- 1,2,3...
1. Select the PLC to be added to from the project tree.
  2. Either select **Edit - New NC**, or right-click and select **New NC** from the pop-up menu.

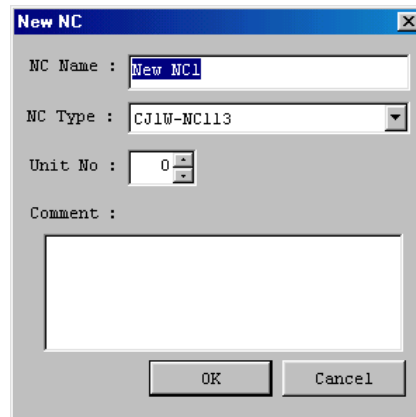

3. Enter the *NC Name*. *New NC* $\square$  (where  $\square$  = 1, 2 etc.) is the default name.
4. Set the *NC Type* by click the *NC Type* drop-down list and selecting.
5. Select the *Unit No.* allocated to the Position Control Unit (as a Special I/O Unit)
6. Enter a comment if required.
7. Click the **OK** Button to add the Position Control Unit to the project.

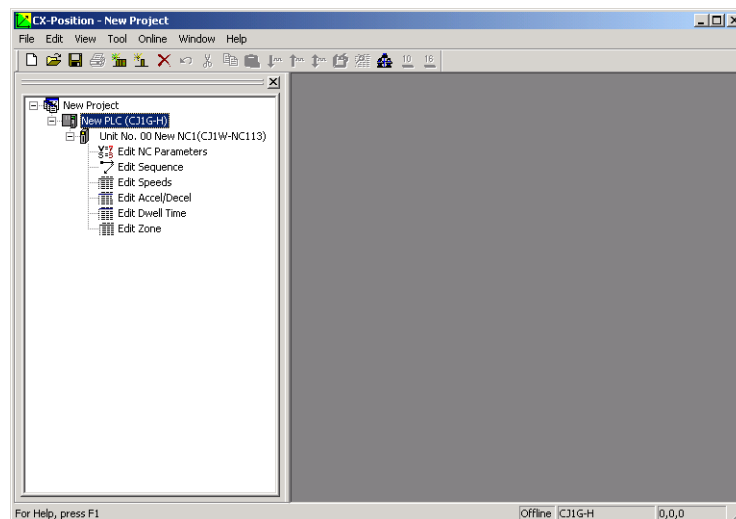

### 3-3-2 Deleting a Position Control Unit

- 1,2,3...
1. Select the Position Control Unit to be deleted from the project tree, and select **Edit - Remove DEL**, press the **DEL** Key, or right-click and select **Remove - DEL** from the pop-up menu.
  2. A dialog box will be displayed asking "Do you want to delete?" Click the **OK** Button.

## 3-4 Automatic Position Control Unit Search

When online, data from all the Position Control Units mounted in the online PLC can be read to automatically create NCs within a specified PLC. At the same time, all the data read from the Position Control Units of the specified PLC can be added as project data.

- 1,2,3...
1. Create a PLC by either select **Edit - New PLC**, or right-click and select **New PLC** from the pop-up menu.
  2. Select the PLC from the project tree and then select **Online - Automatic NC Search**.

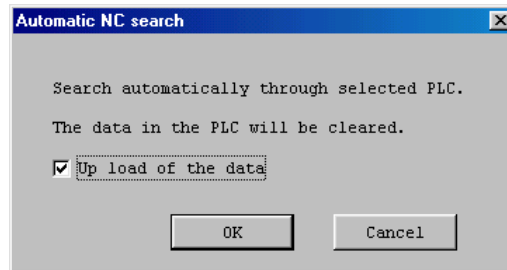

The Automatic NC Search Dialog Box, shown above, will be displayed.

3. Select the data upload checkbox to read all the data from the Position Control Units.
4. Click the **OK** Button to create NCs automatically. If there is data to be uploaded, the following window will appear.

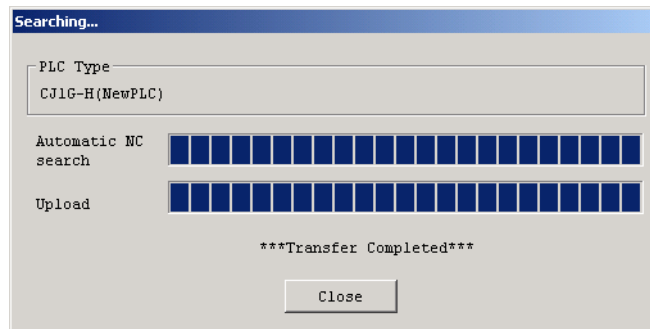

If there is no data to be uploaded, the following window will appear.

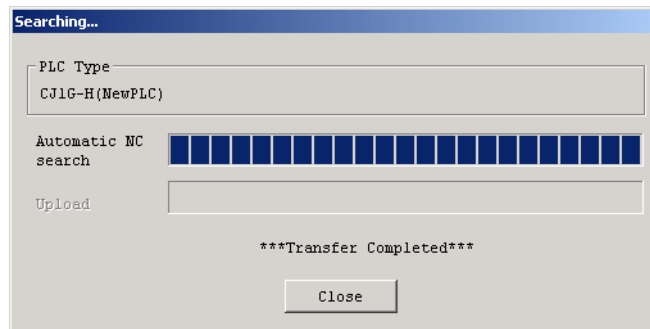





# SECTION 4

## Editing Settings

This section describes the procedures used to edit settings. This manual describes on the possible range of settings and setting procedures. Refer to the *Operation Manuals* for individual Position Control Units for details on the settings.

4-1	Overview . . . . .	48
4-2	Setting Editing Windows . . . . .	51
4-2-1	Displaying Setting Editing Windows . . . . .	52
4-2-2	Editing Settings . . . . .	56
4-2-3	Switching Setting Display Formats . . . . .	58
4-2-4	Clearing Settings . . . . .	58
4-2-5	Copying Axis Settings . . . . .	59
4-3	Editing Parameter Settings . . . . .	60
4-3-1	Parameter Setting Editing Window . . . . .	60
4-3-2	Editing Parameter Settings . . . . .	60
4-4	Editing Sequence Settings . . . . .	61
4-4-1	Sequence Editing Window . . . . .	61
4-4-2	Editing Sequence Settings . . . . .	62
4-5	Editing Speed Settings . . . . .	63
4-5-1	Speed Setting Editing Window . . . . .	63
4-5-2	Editing Speed Settings . . . . .	63
4-6	Editing Acceleration/Deceleration Time Settings . . . . .	64
4-6-1	Acceleration/Deceleration Time Setting Window . . . . .	64
4-6-2	Editing Acceleration/Deceleration Time Settings . . . . .	64
4-7	Editing Dwell Time Settings . . . . .	65
4-7-1	Dwell Time Setting Window . . . . .	65
4-7-2	Editing Dwell Time Settings . . . . .	65
4-8	Editing Zone Settings . . . . .	66
4-8-1	Zone Setting Window . . . . .	66
4-8-2	Editing Zone Settings . . . . .	66

## 4-1 Overview

There are 6 types of settings used in CS1W-NC□□3/CJ1W-NC□□3 Position Control Units. Setting items, setting ranges and default values are shown in the following table.

Refer to the following operation manuals for details on specific settings.

### Reference Manuals:

- SYSMAC CS1W-NC113/133/213/233/413/433 Position Control Units Operation Manual (W376)
- SYSMAC CJ1W-NC113/133/213/233/413/433 Position Control Units Operation Manual (W397)

### Parameters

Item	Setting range	Default setting
Unit set (unit setting)	Pulse, mm, or inches	Pulse
Pulse rate	0.0001 to 1.0000 (See note 1.)	1.0000
Output pulse selection	CW/CCW output or pulse/direction output	CW/CCW output
Output pulse direction (See note 2.)	Not reversed/Reversed	Not reversed
Limit input sig type (limit input signal type)	N.C. or N.O.	N.C.
Ori prox sig type (origin proximity signal type)	N.C. or N.O.	N.O.
Ori sig type (origin signal type)	N.C. or N.O.	N.O.
Emerg stop fun (emergency stop function)	Only pulse output or error counter reset	Only pulse output
Non-origin setting (no origin setting)	Retain prior status or forcibly change to origin undefined status	Retain prior status
Set operation mode (operating mode setting)	Mode 0, Mode 1, Mode 2, or Mode 3	Mode 0
Ori search operation (origin search operation) (See note 3.)	Reverse mode 1, Reverse mode 2, Single-direction mode, or Reverse mode 3	Reverse mode 1
Ori search method	Method 0, Method 1, Method 2, or Method 3	Method 0
Ori search dir (origin search direction)	Clockwise (CW) or counterclockwise (CCW)	CW
Position-preset origin search (See note 2.)	Disabled/Enabled	Disabled
Top speed (See notes 4 and 5.)	00000001 to 0007A120 Hex (1 to 500,000 pps)	0007A120 (500,000)
Start speed (See notes 4 and 5.)	00000000 to 0007A120 Hex (0 to 500,000 pps)	00000000 (0)
Ori search high speed (See notes 4 and 5.)	00000001 to 0007A120 Hex (1 to 500,000 pps)	000061A8 (25,000)
Ori search low speed (See notes 4 and 5.)	00000001 to 0007A120 Hex (1 to 500,000 pps)	000009C4 (2,500)
Ori compensation value (origin compensation value) (See notes 4 and 5.)	C0000001 to 3FFFFFFF Hex ( $\pm 1,073,741,823$ pulses)	00000000 (0)
Backlash comp (backlash compensation) (See notes 4 and 5.)	0000 to 270F Hex (0 to 9,999 pulses)	0000 (0)
Backlash speed (See notes 4 and 5.)	00000000 to 0007A120 Hex (0 to 500,000 pps)	00000000 (0)
Acc/Dec curve (acceleration/deceleration curve) (See note 6.)	Trapezoid or S-curve	Trapezoid
Acc/Dec time specification (Acceleration/Deceleration time specification) (See note 4.)	Maximum speed interval/Target speed interval	Maximum speed interval
Acc time (acceleration time) (See note 4.)	00000000 to 0003D090 Hex (0 to 250,000 ms)	00000064 (100)
Dec time (deceleration time) (See note 4.)	00000000 to 0003D090 Hex (0 to 250,000 ms)	00000064 (100)

Item	Setting range	Default setting
Positioning mon time (positioning monitor time) (See note 4.)	0000 to 270F Hex (0 to 9,999 pulses) (See note 7.)	270F (9,999)
CCW limit (See notes 4 and 5.)	C0000001 to 3FFFFFFF Hex ( $\pm 1,073,741,823$ pulses)	C0000001 (-1,073,741,823)
CW limit (See notes 4 and 5.)	C0000001 to 3FFFFFFF Hex ( $\pm 1,073,741,823$ pulses)	3FFFFFFF (+1,073,741,823)
Initial pulse specification	250 pps or top speed	250 pps

- Notes**
- Always 1 if the unit is set to *Pulse*.
  - If these parameters are not set to their default settings, it will not be possible to download parameters to a Pre-version 2.0 Position Control Unit or a Position Control Unit with a unit version of 2.1 or earlier (with embedded software version 2.1 or lower). These parameter cannot be set with CX-Position version 2.0 or lower.
  - If reverse mode 3 is set, it will not be possible to download parameters to a Pre-version 2.0 Position Control Unit or a Position Control Unit with a unit version of 2.1 or earlier (with the embedded software version 2.1 or lower). Reverse mode 3 cannot be set with CX-Position version 2.0 or lower.
  - Settings can be entered and displayed in either hexadecimal or decimal format depending on the setting of the display format.
  - Ranges given in the table are for when the displayed value's unit is set to *Pulse*. When the set unit is millimeters or inches and the pulse rate is set to a value other than 1, the values displayed will change to the specified set value  $\times$  the pulse rate. The following settings are also affected:
    - Position
    - Zone
    - Speed
  - Setting the target speed interval on a Pre-version 2.0 Position Control Unit (with embedded software version 1.00) will cause an error when data is downloaded from the personal computer to the Position Control Unit. Use the default setting of maximum speed interval. Refer to information on unit versions at the front of this manual for the relationship between the unit version of the Position Control Unit and the version of the embedded system software, and the confirmation methods.
  - The position monitoring time must be set only when the operating mode is set to Mode 2 or Mode 3.

**Sequences (X/Y/Z/U Axes: #0 to #99)**

Only the X-axis settings are used for the CS1W-NC113/133 and CJ1W-NC113/133, and only the X- and Y-axis settings are used for the CS1W-NC213/233 and CJ1W-NC213/233. Settings can be entered in either hexadecimal or decimal format depending on display setting.

Item	Setting range
Position data	C0000001 to 3FFFFFFF Hex ( $\pm 1,073,741,823$ pulses)
Axis set	X/Y/Z/U
Output code (See note 1.)	00 to 0F Hex (0 to 15)
Position designation	0 (absolute position) or 1 (relative position)
End code (completion code) (See note 1.)	00 to 06 Hex (0 to 6)
Dwell # (See note 1.)	00 to 13 Hex (0 to 19)

Item	Setting range
Accel. # (See note 1.)	0 to 9 Hex (0 to 9)
Decel. # (See note 1.)	0 to 9 Hex (0 to 9)
Start speed (See note 1.)	00 to 63 Hex (0 to 99)
Target speed (See note 1.)	00 to 63 Hex (0 to 99)

- Notes**
1. These values can be entered and displayed in either hexadecimal or decimal format by setting the display format.
  2. Ranges given in the table are for when the displayed value's unit is set to *Pulse*. When the set unit is millimeters or inches and the pulse rate is set to a value other than 1, the values displayed will change to the specified set value × the pulse rate.

**Speeds (X/Y/Z/U Axes: #0 to #99)**

Only the X-axis settings are used for the CS1W-NC113/133 and CJ1W-NC113/133, and only the X- and Y-axis settings are used for the CS1W-NC213/233 and CJ1W-NC213/233. Settings can be entered and displayed in either hexadecimal or decimal format depending on the setting of the display format.

Item	Setting range
Speed (See notes 1 and 2.)	00000000 to 000F4240 Hex (0 to 1,000,000) (pps)

- Notes**
1. Settings can be entered and displayed in either hexadecimal or decimal format depending on the setting of the display format.
  2. When the displayed value's set unit is *Pulse*. When the set unit is *mm* or *inches* and the pulse rate is set to other than 1, the value displayed will change.
  3. The speeds set above can be set as interpolation speeds. However, make sure that the maximum speed of individual axes does not exceed 500,000 (pps) or the maximum speed set in the parameter settings.

**Acceleration/Deceleration (X/Y/Z/U Axes: #1 to #9)**

Only the X-axis settings are used for the CS1W-NC113/133 and CJ1W-NC113/133, and only the X- and Y-axis settings are used for the CS1W-NC213/233 and CJ1W-NC213/233. Settings can be entered and displayed in either hexadecimal or decimal format depending on the setting of the display format.

Item	Setting range
Acceleration (See note.)	00000000 to 0003D090 Hex (0 to 250,000) (ms)
Deceleration (See note.)	00000000 to 0003D090 Hex (0 to 250,000) (ms)

**Note** Settings can be entered and displayed in either hexadecimal or decimal format depending on the setting of the display format.

**Dwell Time (X/Y/Z/U Axes: #1 to #19)**

Only the X-axis settings are used for the CS1W-NC113/133 and CJ1W-NC113/133, and only the X- and Y-axis settings are used for the CS1W-NC213/233 and CJ1W-NC213/233. Settings can be entered and displayed in either hexadecimal or decimal format depending on the setting of the display format.

Item	Setting range
Dwell time (See note.)	0000 to 03E7 Hex (0.00 to 9.99) (s)

**Note** Settings can be entered and displayed in either hexadecimal or decimal format depending on the setting of the display format.

**Zone (X/Y/Z/U Axes: Zone 0 to Zone 2)**

Only the X-axis settings are used for the CS1W-NC113/133 and CJ1W-NC113/133, and only the X- and Y-axis settings are used for the CS1W-NC213/233 and CJ1W-NC213/233. Settings can be entered and displayed in either hexadecimal or decimal format depending on the setting of the display format.

Item	Setting range
Zone (See notes 1 and 2.)	C0000001 to 3FFFFFFF Hex ( $\pm 1,073,741,823$ ) (pulses)

- Note**
- Settings can be entered and displayed in either hexadecimal or decimal format depending on the setting of the display format.
  - When the displayed value's set unit is *Pulse*. When the set unit is *mm* or *inches* and the pulse rate is set to other than *1*, the value displayed will change to specified set value  $\times$  *Pulse Rate*.

## 4-2 Setting Editing Windows

Use the following procedures to display the window shown below.

To create a new project:

- Select **File- New**; or
- Press the **Ctrl+N** Keys; or
- Select the **New Project** Icon from the toolbar.

To select an existing project:

- Select **File - Open**; or
- Press the **Ctrl+O** Keys; or
- Select the **Open** Icon from the toolbar.

**Note** Refer to *SECTION 5 Saving and Reading Projects* for information on opening an existing project

Example: The following window will be displayed after creating a new project

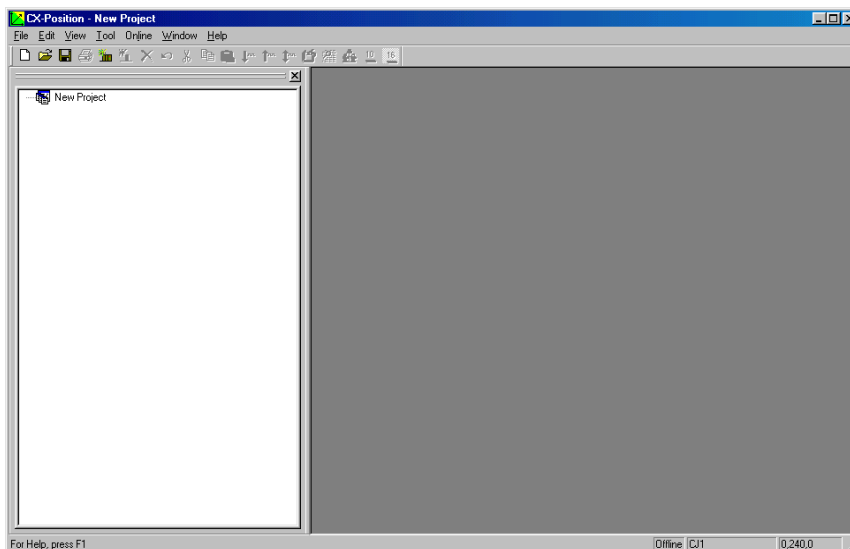

### 4-2-1 Displaying Setting Editing Windows

Use the following procedures to display individual Setting Editing Windows in project window.

#### To Display Individual Setting Editing Windows

With the project tree displayed, select the settings to be displayed for the specified NC, and either double-click or press the **Enter** Key.

X- and Y-axis editing windows will be displayed for 2-axis Position Control Units; X-, Y-, Z- and U-axis editing windows will be displayed for 4-axis Position Control Units

#### To Display the Parameter Editing Window

1,2,3...

1. Under the NC on the project tree, either double-click **Edit NC Parameters**, or select it and press the **Enter** Key.
2. The following window will be displayed.

Name	Address				Setting value
	X axis	Y axis	Z axis	U axis	X axis
Unit set	----	----	----	----	0:Pulses
Pulse rate	----	----	----	----	1
Output pulse selection	0004	0020	003C	0058	0: CW/CCW output
Output pulse direction	0004	0020	003C	0058	0: Not reversed
Limit input signal type	0004	0020	003C	0058	0: N.C. contact
Ori prox sig type	0004	0020	003C	0058	1: N.O. contact
Origin input signal type	0004	0020	003C	0058	1: N.O. contact
Emergency stop input	0004	0020	003C	0058	0: Only the pulse output
No-origin setting	0004	0020	003C	0058	0: Retain prior status
Operation mode selection	0005	0021	003D	0059	0: Mode 0
Origin search operation	0005	0021	003D	0059	0: Reverse mode 1
Origin detection method	0005	0021	003D	0059	0: Method 0
Origin search direction	0005	0021	003D	0059	0: CW direction
Position-preset Origin Search	0005	0021	003D	0059	0: Disabled
Maximum speed	0006	0022	003E	005A	500000
Initial speed	0008	0024	0040	005C	0
Origin search high speed	000A	0026	0042	005E	25000
Ori search prox speed	000C	0028	0044	0060	2500
Origin compensation value	000E	002A	0046	0062	0
Backlash compensation	0010	002C	0048	0064	0

**To Display the Sequence Editing Window**

- 1,2,3... 1. Under the NC on the project tree, either double-click *Edit Sequence*, or select it and press the **Enter** Key
2. The following window will be displayed.

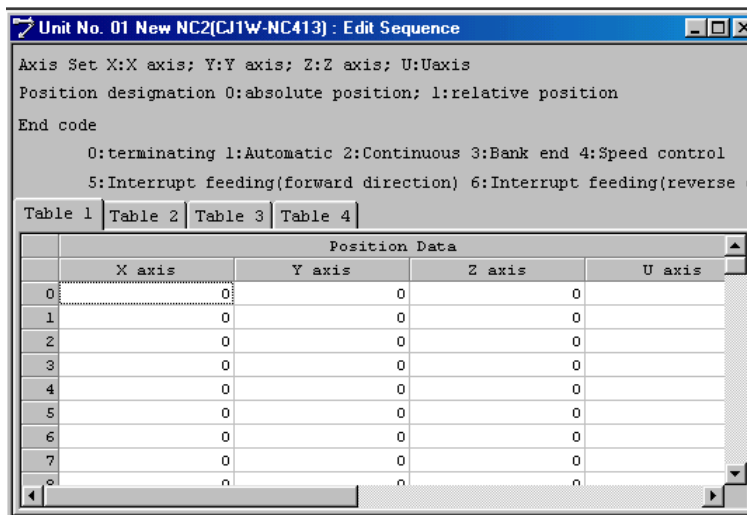

**To Display the Speed Editing Window**

- 1,2,3... 1. Under the NC on the project tree, either double-click *Edit Speeds*, or select it and press the **Enter** Key.
2. The following window will be displayed.

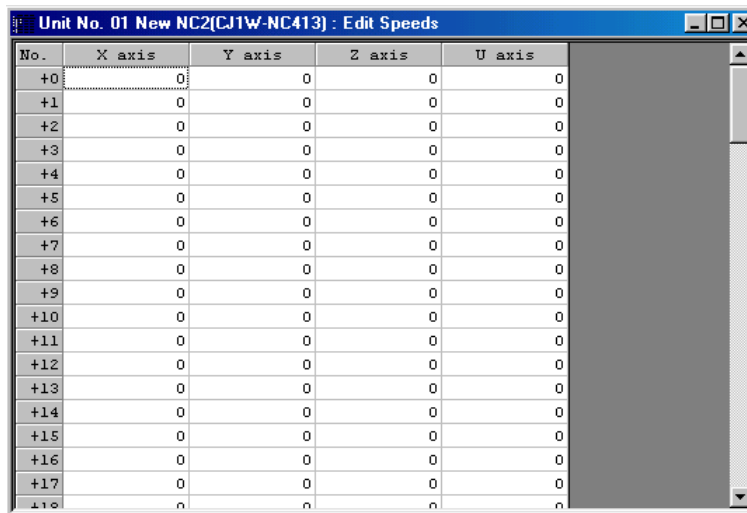

**To Display the Acceleration/Deceleration Editing Window**

- 1,2,3... 1. Under the NC on the project tree, either double-click *Edit Accel/Decel*, or select it and press the **Enter** Key



- The following window will be displayed.

No.	X axis		Y axis		Z axis		U axis
	Accel	Decel	Accel	Decel	Accel	Decel	Accel
+1	0	0	0	0	0	0	0
+2	0	0	0	0	0	0	0
+3	0	0	0	0	0	0	0
+4	0	0	0	0	0	0	0
+5	0	0	0	0	0	0	0
+6	0	0	0	0	0	0	0
+7	0	0	0	0	0	0	0
+8	0	0	0	0	0	0	0
+9	0	0	0	0	0	0	0

**To Display the Dwell Time Editing Window**

1,2,3...

- Under the NC on the project tree, either double-click *Edit Dwell Time*, or select it and press the **Enter** Key
- The following window will be displayed.

No.	X axis	Y axis	Z axis	U axis
+1	0	0	0	0
+2	0	0	0	0
+3	0	0	0	0
+4	0	0	0	0
+5	0	0	0	0
+6	0	0	0	0
+7	0	0	0	0
+8	0	0	0	0
+9	0	0	0	0
+10	0	0	0	0
+11	0	0	0	0
+12	0	0	0	0
+13	0	0	0	0
+14	0	0	0	0
+15	0	0	0	0
+16	0	0	0	0
+17	0	0	0	0
+18	0	0	0	0
+19	0	0	0	0

**To Display the Zone Editing Window**

- 1,2,3... 1. Under the NC on the project tree, either double-click *Edit Zone*, or select it and press the **Enter** Key
2. The following window will be displayed.

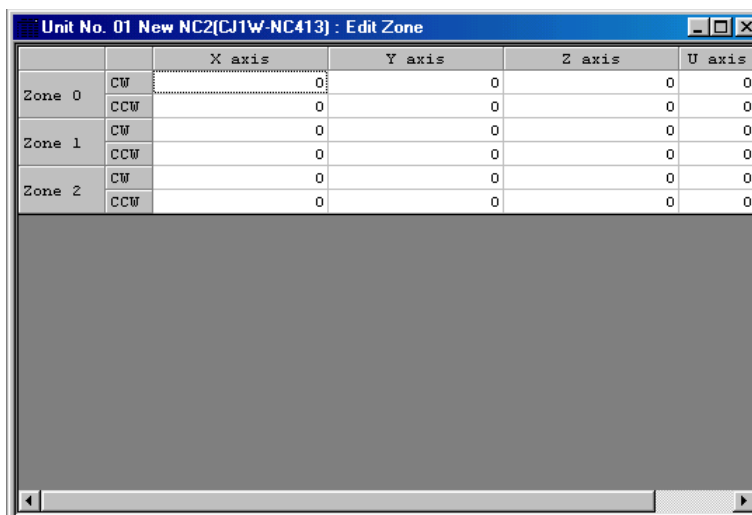

**To Display All Editing Windows**

To display all editing windows, select the NC and select **Edit - Display All**. Example: The following window will be displayed after selecting **Edit - Display All**.

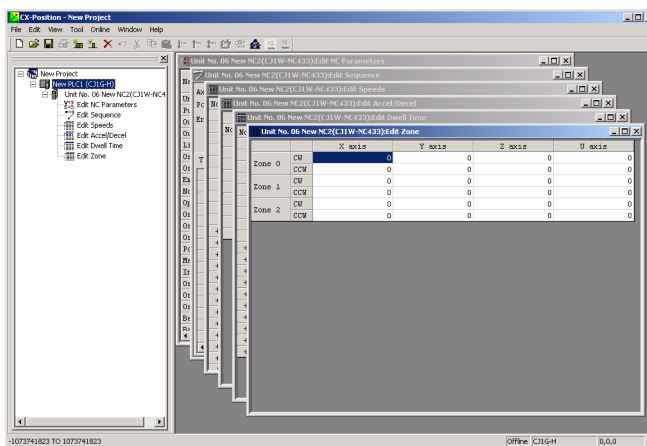

If multiple setting windows are displayed, select the window to be edited to activate it, and edit individual settings.

**To Use Each Editing Window**

Use the **Window** Menu to select various window displays, minimize, and close windows, and arrange their contents.

Main menu	Command	Function
<b>Window</b>	<b>Display All</b>	Displays all minimized windows.
	<b>Icon All</b>	Minimizes all windows.
	<b>Cascade</b>	Cascades windows.
	<b>Tile Horizontally</b>	Tiles windows horizontally.
	<b>Tile Vertically</b>	Tiles windows vertically.
	<b>Arrange Icons</b>	Arranges iconized windows within the window.
	<b>Close All</b>	Closes all windows.
	<b>Project</b>	Selects the project tree.

Windows can also be displayed and minimized by clicking directly on the upper-right window buttons.

Click a minimized window or on the left side of any window's title bar to display the following menus.

Minimized window

Title bar

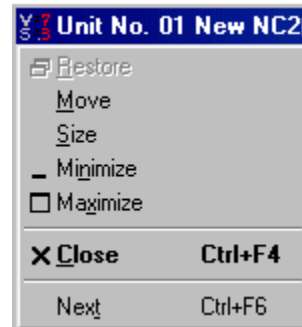
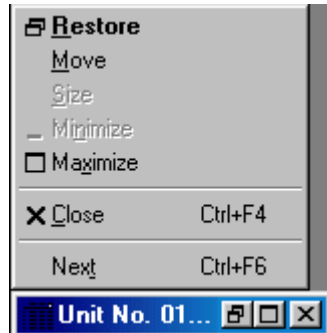

Menu items and functions will be as follows.

Menu item	Function
<b>Restore</b>	Restores minimized windows to the project window.
<b>Move</b>	Moves windows.
<b>Size</b>	Sizes windows.
<b>Minimize</b>	Minimizes windows.
<b>Maximize</b>	Maximizes windows.
<b>Close</b>	Closes windows.
<b>Next</b>	Activates next window.

**4-2-2 Editing Settings**

All settings can be set by selecting items from the drop-down lists in the Setting Editing Windows or by directly entering item list numbers. Use one of the following procedures to set individual setting types.

### To Enter Settings

#### Selecting Items From Drop-Down Lists

- 1,2,3...**
1. In the Setting Editing Window, select the setting to be made, and either click the drop-down list arrow, or press the **Space Bar**.

Example: The following window will be displayed when selecting from the drop-down list on the Pulse Rate Window

Name	Address				Setting value
	X axis	Y axis	Z axis	U axis	X axis
Unit set	----	----	----	----	0:Pulses
Pulse rate	----	----	----	----	0:Pulses
Output pulse selection	0004	0020	003C	0058	1:mm
Output pulse direction	0004	0020	003C	0058	2:inch
Limit input signal type	0004	0020	003C	0058	0:N.C. contact

2. Select an item from the expanded drop-down list either by click it directly, or by using the **Up** or **Down** Keys or entering its list number (0, 1, 2 etc.).
3. Press the **Enter** Key to collapse the list and set the settings.

#### Entering Settings Using List Numbers

- 1,2,3...**
1. In the Setting Editing Window, enter the desired settings directly.
  2. Press the **Enter** Key, or use the Up or Down Keys, to set the setting.

- Note**
1. Settings can be displayed in either hexadecimal or decimal format. (Refer to 4-2-3 *Switching Setting Display Formats*.)
  2. When the Setting Editing Window is active, the left-hand side of its status bar will display the possible range for entries.



Possible range for entries is displayed

Press the **Backspace** Key before setting an entry to alter it.

- Note**
- If entering settings directly, decimal values must be entered starting with the leading zero (i.e., 0.□□), not with the decimal point (i.e., .□□).

#### To Move the Cursor

Move the cursor in individual Setting Editing Windows either by using the Cursor Keys or by clicking in the window directly.

#### To Move the Window

Settings that cannot be displayed in a single window can be viewed either by pressing the **PageDown** Key or by using the scroll bar on the right-hand side of the window.

### 4-2-3 Switching Setting Display Formats

Settings in any Setting Editing Window can be displayed in either hexadecimal or decimal format.

#### Switching the Current Settings Display Format

Switch the display format by selecting *Hexadecimal* or *Decimal* under **View - Change Display** in the Setting Editing Window or by right-clicking and selecting *Hexadecimal* or *Decimal* from the pop-up menu.

Example: The following windows will be displayed for speed settings in hexadecimal (right) and decimal (left) formats

Decimal Notation

No.	X axis	Y axis
+0	500	500
+1	1000	1000
+2	2000	2000
+3	4000	4000
+4	8000	8000

Hexadecimal Notation

No.	X axis	Y axis
+0	1F4	1F4
+1	3E8	3E8
+2	7D0	7D0
+3	FA0	FA0
+4	1F40	1F40

#### Switching the Settings Display Format on Startup

Set the display format when starting up CX-Position by selecting **Tools - Options - Default Display Format**. Decimal is the default display format. To switch to hexadecimal display, select the *Hexadecimal Display* option.

### 4-2-4 Clearing Settings

Set parameter settings can be made into default settings and non-parameter setting ranges can be cleared.

#### To Clear to Default Settings

Use the following procedure to clear axis settings to their default values.

1,2,3...

1. With the Parameter Setting Editing Window enabled, either select **Edit - Defaults Clear**, or right-click and select **Defaults Clear** from the pop-up menu.

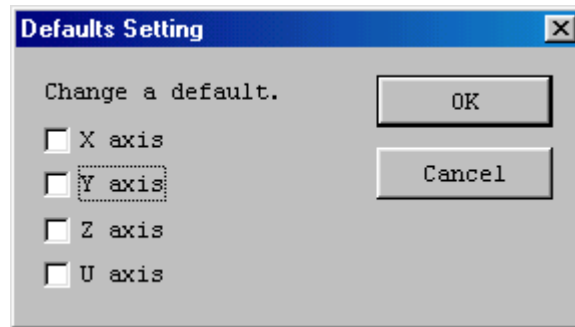

2. Select the axis for which settings are to be cleared to the defaults.
3. Click the **OK** Button.
4. A dialog box will be displayed asking if the settings should be returned to their default values. Click the **OK** Button.

**To Clear Setting Ranges**

Non-parameter settings can also be cleared.

1,2,3...

1. In the (non-parameter) editing window, select the settings to be cleared, or designate the range by clicking and dragging.

No.	X axis	Y axis
+0	500	500
+1	1000	1000
+2	2000	2000
+3	4000	4000
+4	8000	8000

2. Select **Edit - Clear**, or right-click and select **Clear** from the pop-up menu.

No.	X axis	Y axis
+0	0	0
+1	0	0
+2	0	0
+3	0	0
+4	0	0

**Note** Under the **Edit** Menu, *Default Clear* is enabled when parameter settings are selected, and *Clear* is enabled when non-parameter settings are active.

### 4-2-5 Copying Axis Settings

For 2-axis and 4-axis Position Control Units, data can be copied from one axis to another axis by selecting the source and destination axes.

**Applicable Position Control Units**

4-axis NCs: CS1W-NC413/NC433 and CJ1W-NC413/NC433

2-axis NCs: CS1W-NC213/NC233 and CJ1W-NC213/NC233

**Settings That Can Be Copied**

The following settings can all be copied using a single procedure.

- Parameters
- Sequences
- Speeds
- Accelerations/Decelerations
- Dwell Times
- Zones

1,2,3...

1. Select **Edit - Copy Axis**

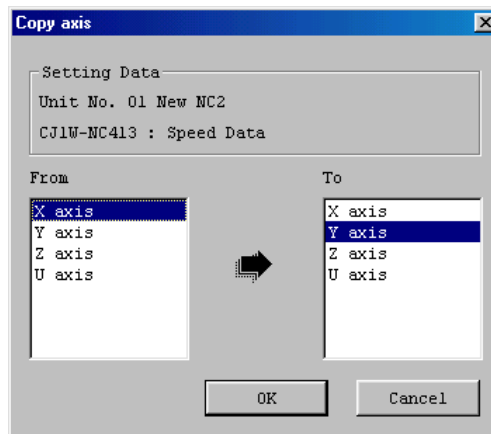

2. Under *From*, select the axis to be copied from. The default settings are from X axis to Y axis.

The *From* axis cannot be the same as the *To* axis.

For 4-axis Position Control Units, if the same axis is clicked for the *To* axis as the one already selected for the *From* axis, the next *To* axis will be selected automatically (in the order *Y, Z, U, X*).

More than one axis can be selected for the *To* axis (except for the axis already selected as the *From* axis).

For 2-axis Position Control Units, selecting the *Y* axis as the *From* axis will automatically make the *X* axis the *To* axis, and vice-versa.

3. Change the *To* axis by click and selecting a different axis.
4. Verify the *From* and *To* axes, and click the **OK** Button.

## 4-3 Editing Parameter Settings

### 4-3-1 Parameter Setting Editing Window

Select *Parameters* on the project tree, and either double-click or press the **Enter** Key.

Example: The following will be displayed as the 4-axis Position Control Unit parameter Setting Editing Window.

Name	Address				Setting value
	X axis	Y axis	Z axis	U axis	X axis
Unit set	----	----	----	----	0:Pulses
Pulse rate	----	----	----	----	1
Output pulse selection	0004	0020	003C	0058	0:CW/CCW output
Output pulse direction	0004	0020	003C	0058	0:Not reversed
Limit input signal type	0004	0020	003C	0058	0:N.C. contact
Ori prox sig type	0004	0020	003C	0058	1:N.O. contact
Origin input signal type	0004	0020	003C	0058	1:N.O. contact
Emergency stop input	0004	0020	003C	0058	0:Only the pulse output
No-origin setting	0004	0020	003C	0058	0:Retain prior status
Operation mode selection	0005	0021	003D	0059	0:Mode 0
Origin search operation	0005	0021	003D	0059	0:Reverse mode 1
Origin detection method	0005	0021	003D	0059	0:Method 0
Origin search direction	0005	0021	003D	0059	0:CW direction
Position-preset Origin Search	0005	0021	003D	0059	0:Disabled
Maximum speed	0006	0022	003E	005A	500000
Initial speed	0008	0024	0040	005C	0
Origin search high speed	000A	0026	0042	005E	25000
Ori search prox speed	000C	0028	0044	0060	2500
Origin compensation value	000E	002A	0046	0062	0
Backlash compensation	0010	002C	0048	0064	0

### 4-3-2 Editing Parameter Settings

Select a setting or enter settings directly. Refer to *4-2-2 Editing Settings* for editing methods.

#### To Enter Settings

##### Selecting Settings From the Drop-down List

- 1,2,3... 1. In the Setting Editing Window, select the setting to be set, and either click the drop-down list arrow or press the **Space** Bar.
2. Select an item from the expanded drop-down list either by click it directly, or by using the **Up** or **Down** Keys or entering its list number (0, 1, 2 etc.).
3. Press the **Enter** Key to collapse the list and set the settings.

**Entering Settings Using the List Numbers**

- 1,2,3... 1. In the Setting Editing Window, enter directly the setting to be set.  
 2. Press the **Enter Key** or use the **Up** or **Down Keys** to set the setting.

**Clearing to Default Settings**

Use the following procedure to clear the axis settings to their default values. (Refer to 4-2-4 *Clearing Settings* for details.)

- 1,2,3... 1. In the Parameter Setting Editing Window, either select **Edit - Defaults Setting**, or right-click and select **Defaults Setting** from the pop-up menu.  
 2. Select the axis whose settings are to be cleared to the default values.  
 3. Click the **OK Button**.  
 4. A dialog box will be displayed asking if the settings should be returned to their default values. Click the **OK Button**.

**To Copy Axes**

For 2-axis and 4-axis Position Control Units, data can be copied from one axis to another axis by selecting the source and destination axes. (Refer to 4-2-5 *Copying Axis Settings* for details.)

- 1,2,3... 1. Select **Edit - Copy Axis**.  
 2. Under *From* and *To*, select the axes to be copied from and to respectively.  
 3. Click the **OK Button**.

## 4-4 Editing Sequence Settings

### 4-4-1 Sequence Editing Window

On the project tree, either double-click *Edit Sequence*, or select it and press the **Enter Key**.

For single axis Position Control Units, only the *Table 1* Tab will be displayed; for 2-axis Position Control Units, only the *Table 1* and *Table 2* Tabs will be displayed.

Example: The following will be displayed as the 4-axis Position Control Unit sequence Setting Editing Window.

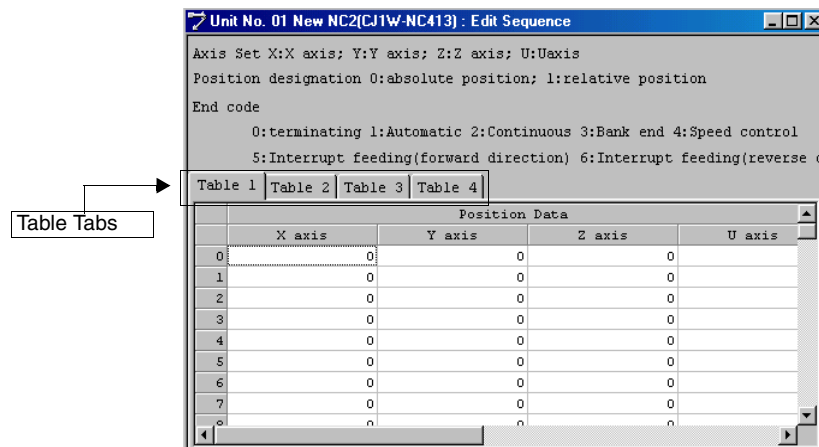



### 4-4-2 Editing Sequence Settings

Enter each sequence setting in order. Refer to 4-2-2 *Editing Settings* for editing methods

The following items and setting ranges will be displayed.

Item	Setting range
Position data	Pulses: C0000001 to 3FFFFFFF Hex ( $\pm 1,073,741,823$ ) mm or inches: pulse set value $\times$ pulse rate
Axis set	X/Y/Z/U
Output code	00 to 0F Hex (0 to 15)
Position designation	0 (absolute position) or 1 (relative position)
End code	00 to 06 Hex (0 to 6) 0 = terminating; 1 = automatic; 2 = continuous; 3 = bank end; 4 = speed control; 5 = interrupt feeding (forward direction); 6 = interrupt feeding (reverse direction)
Dwell #	00 to 13 Hex (0 to 19) (no dwell time for 0)
Accel. #	0 to 9 Hex (0 to 9) (0 = Acceleration time in parameter settings)
Decel. #	0 to 9 Hex (0 to 9) (0 = Deceleration time in parameter settings)
Start speed	00 to 63 Hex (0 to 99)
Target speed	00 to 63 Hex (0 to 99)

No particular axis is allocated to Tables 1 to 4, but between tables the same axis cannot be specified in the same sequence.

Example: The following window will be displayed after setting sequence Numbers 0 to 3 in Table 1 for a 4-axis Position Control Unit.

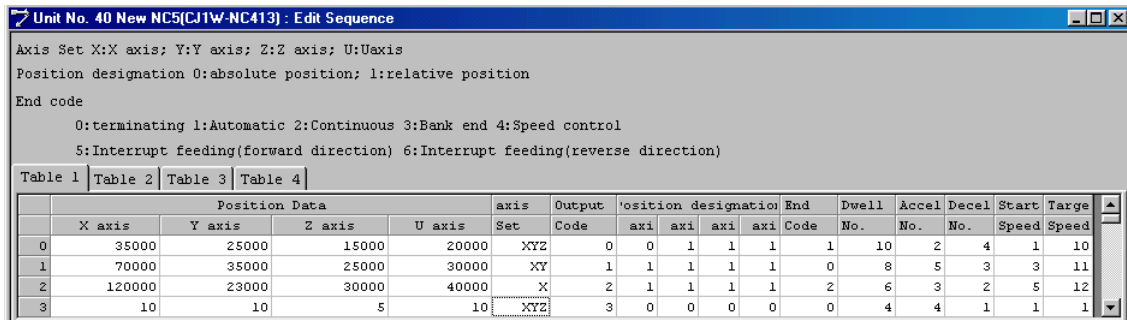

#### To Clear to Default Settings

Use the following procedure to clear specific settings to their default values. (Refer to 4-2-4 *Clearing Settings* for details.)

- 1,2,3... 1. In the Sequence Setting Editing Window, select the settings to be cleared to the default values, or designate the range by clicking and dragging.
2. Select **Edit - Clear**.

#### To Copy Axes

For 2-axis and 4-axis Position Control Units, data can be copied from one axis to another axis by selecting the source and destination axes. (Refer to 4-2-5 *Copying Axis Settings* for details.)

- 1,2,3... 1. Select **Edit - Copy Axis**.
2. Under *From* and *To*, select the axes to be copied from and to respectively.
3. Click the **OK** Button.

## 4-5 Editing Speed Settings

### 4-5-1 Speed Setting Editing Window

On the project tree, either double-click *Edit Speeds*, or select it and press the **Enter** Key.

Example: The following will be displayed as the 4-axis Position Control Unit Speed Setting Editing Window.

No.	X axis	Y axis	Z axis	U axis
+0	0	0	0	0
+1	0	0	0	0
+2	0	0	0	0
+3	0	0	0	0
+4	0	0	0	0
+5	0	0	0	0
+6	0	0	0	0
+7	0	0	0	0
+8	0	0	0	0
+9	0	0	0	0
+10	0	0	0	0
+11	0	0	0	0
+12	0	0	0	0
+13	0	0	0	0
+14	0	0	0	0
+15	0	0	0	0
+16	0	0	0	0
+17	0	0	0	0
+18	0	0	0	0

### 4-5-2 Editing Speed Settings

The speed setting range is from 00000000 to 000F4240 Hex (0 to 1,000,000) (pps). If the pulse rate is set to a value other than 1, the value displayed will change to specified set value times the pulse rate. Refer to 4-2-2 *Editing Settings* for editing methods.

**Note** The speeds set above can be set as interpolation speeds. Make sure, however, that the maximum speed of individual axes does not exceed 500,000 (pps) or the maximum speed set in the parameter settings.

Example: The following will be displayed as the Speed Setting Editing Window.

No.	X axis	Y axis	Z axis	U axis
+0	1000	1000	1000	1000
+1	2000	2000	2000	2000
+2	3000	3000	3000	3000
+3	4000	4000	4000	4000

#### To Clear to Default Settings

Use the following procedure to clear specific settings to their default values. (Refer to 4-2-4 *Clearing Settings* for details.)

- 1,2,3... 1. In the Speed Setting Editing Window, select the settings to be cleared to their default values, or designate the range by clicking and dragging.
2. Select **Edit - Clear**.

#### To Copy Axes

For 2-axis and 4-axis Position Control Units, data can be copied from one axis to another axis by selecting the source and destination axes. (Refer to 4-2-5 *Copying Axis Settings* for details.)

- 1,2,3... 1. Select **Edit - Copy Axis**.
2. Under *From* and *To*, select the axes to be copied from and to respectively.
3. Click the **OK** Button.

## 4-6 Editing Acceleration/Deceleration Time Settings

### 4-6-1 Acceleration/Deceleration Time Setting Window

On the project tree, either double-click *Edit Accel/Decel*, or select it and press the **Enter** Key.

Example: The following will be displayed as the 4-axis Position Control Unit Acceleration/Deceleration Time Setting Editing Window.

No.	X axis		Y axis		Z axis		U axis
	Accel	Decel	Accel	Decel	Accel	Decel	Accel
+1	0	0	0	0	0	0	0
+2	0	0	0	0	0	0	0
+3	0	0	0	0	0	0	0
+4	0	0	0	0	0	0	0
+5	0	0	0	0	0	0	0
+6	0	0	0	0	0	0	0
+7	0	0	0	0	0	0	0
+8	0	0	0	0	0	0	0
+9	0	0	0	0	0	0	0

### 4-6-2 Editing Acceleration/Deceleration Time Settings

The acceleration/deceleration time setting range is from 00000000 to 0003D090 Hex (0 to 250,000) (ms). After the settings have been entered and the **Enter** Key pressed, the cursor will move to the next setting.

Example: The following will be displayed as the Acceleration/Deceleration Time Setting Editing Window.

No.	Y axis		Z axis		U axis	
	Accel	Decel	Accel	Decel	Accel	Decel
+1	1000	2000	300	100	400	200
+2	12000	10000	600	200	800	400
+3	14000	12000	900	300	1200	600

#### To Clear to Default Settings

Use the following procedure to clear specific settings to their default values. (Refer to 4-2-4 *Clearing Settings* for details.)

- 1,2,3...
- In the Acceleration/Deceleration Setting Editing Window, select the settings to be cleared to their default values, or designate the range by clicking and dragging.
  - Select **Edit - Clear**.

#### To Copy Axes

For 2-axis and 4-axis Position Control Units, data can be copied from one axis to another axis by selecting the source and destination axes. (Refer to 4-2-5 *Copying Axis Settings* for details.)

- 1,2,3...
- Select **Edit - Copy Axis**.
  - Under *From* and *To*, select the axes to be copied from and to respectively.
  - Click the **OK** Button.

## 4-7 Editing Dwell Time Settings

### 4-7-1 Dwell Time Setting Window

On the project tree, either double-click *Edit Dwell Time*, or select it and press the **Enter** Key.

Example: The following will be displayed as the 4-axis Position Control Unit Dwell Time Setting Editing Window.

No.	X axis	Y axis	Z axis	U axis
+1	0	0	0	0
+2	0	0	0	0
+3	0	0	0	0
+4	0	0	0	0
+5	0	0	0	0
+6	0	0	0	0
+7	0	0	0	0
+8	0	0	0	0
+9	0	0	0	0
+10	0	0	0	0
+11	0	0	0	0
+12	0	0	0	0
+13	0	0	0	0
+14	0	0	0	0
+15	0	0	0	0
+16	0	0	0	0

### 4-7-2 Editing Dwell Time Settings

The dwell time setting range is from 0000 to 03E7 Hex (0.00 to 0.99) (s). Refer to *4-2-2 Editing Settings* for editing methods.

Example: The following will be displayed as the Dwell Time Setting Editing Window.

No.	X axis	Y axis	Z axis	U axis
+1	0.20	0.10	1.00	0.50
+2	0.40	0.20	2.00	1.00
+3	0.60	0.30	3.00	1.50
+4	0.80	0.40	4.00	2.00

#### To Clear to Default Settings

Use the following procedure to clear specific settings to their default values. (Refer to *4-2-4 Clearing Settings* for details.)

- 1,2,3... 1. In the Dwell Time Setting Editing Window, select the settings to be cleared to their default values, or designate the range by clicking and dragging.
2. Select **Edit - Clear**.

#### To Copy Axes

For 2-axis and 4-axis Position Control Units, data can be copied from one axis to another axis by selecting the source and destination axes. (Refer to *4-2-5 Copying Axis Settings* for details.)

- 1,2,3... 1. Select **Edit - Copy Axis**.
2. Under *From* and *To*, select the axes to be copied from and to respectively.
3. Click the **OK** Button.

## 4-8 Editing Zone Settings

### 4-8-1 Zone Setting Window

On the project tree, either double-click *Edit Zone*, or select it and press the **Enter** Key.

Example: The following will be displayed as the 4-axis Position Control Unit Zone Setting Editing Window.

Unit No. 40 New NC5(CJ1W-NC413) : Edit Zone					
		X axis	Y axis	Z axis	U axis
Zone 0	CCW	0	0	0	0
	CCW	0	0	0	0
Zone 1	CCW	0	0	0	0
	CCW	0	0	0	0
Zone 2	CCW	0	0	0	0
	CCW	0	0	0	0

### 4-8-2 Editing Zone Settings

The zone setting range is as follows.

Pulse: C0000001 to 3FFFFFFF Hex ( $\pm 1,073,741,823$ ) (pulse)

mm or inches: Above set value  $\times$  pulse rate

Example: The following will be displayed as the Zone Setting Editing Window (hexadecimal display shown).

Unit No. 40 New NC5(CJ1W-NC413) : Edit Zone					
		X axis	Y axis	Z axis	U axis
Zone 0	CCW	1FFFFFFF	FFFFFFF	2FFFFFFF	7FFFFFFF
	CCW	E0000001	F0000001	D0000001	F8000001
Zone 1	CCW	17FFFFF	7FFFFF	D000001	6FFFFFFF
	CCW	8000000	800000	E0000001	1FFFFF
Zone 2	CCW	3FFFFFF	5FFFFFFF	7FFFFFF	9FFFFFF
	CCW	FFC001	FFA00001	FF80001	FF60001

#### To Clear to Default Settings

Use the following procedure to clear specific setting to their default values. (Refer to 4-2-4 *Clearing Settings* for details.)

- 1,2,3... 1. In the Zone Setting Editing Window, select the settings to be cleared to their default values, or designate the range by clicking and dragging.
2. Select **Edit - Clear**.

#### To Copy Axes

For 2-axis and 4-axis Position Control Units, data can be copied from one axis to another axis by selecting the source and destination axes. (Refer to 4-2-5 *Copying Axis Settings* for details.)

- 1,2,3... 1. Select **Edit - Copy Axis**.
2. Under *From* and *To*, select the axes to be copied from and to respectively.
3. Click the **OK** Button.

# SECTION 5

## Saving and Reading Projects

This section provides information about saving and reading files.

5-1	Saving Projects .....	68
5-1-1	Saving a Project .....	68
5-2	Reading Projects .....	68
5-2-1	Reading a Project .....	68
5-2-2	Importing C200HW-NC□□□ NC Settings .....	69

## 5-1 Saving Projects

### 5-1-1 Saving a Project

To save a project, select **File - Save Project (Ctrl+S)** to resave an edited project under the same name or **File - Save Project As (Ctrl+A)** to save a new or existing project under a new name.

#### To Save a Project Under a New Name

- 1,2,3... 1. Select **File - Save Project As** to display the *Save As* Window.

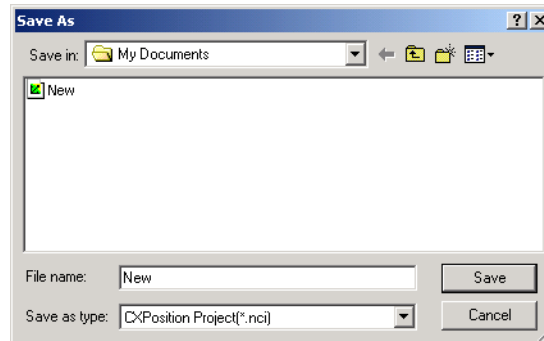

2. Enter the folder to be saved in, or select one by click the arrow to expand the drop-down list. (The folder into which CX-Position was installed will be the default folder.) Enter or select the file name, and the *Save as* file type (CX-Position default file type: \*.nci) and press the **Save** Button.

## 5-2 Reading Projects

### 5-2-1 Reading a Project

Select **File - Open (Ctrl+O)** to open a saved project.

- 1,2,3... 1. Select **File - Open**.

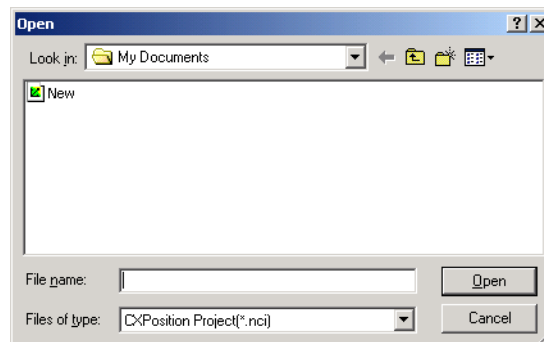

2. From the *Look in* drop-down list, select the drive and folder to which the project was saved.  
 3. Enter the project name, or select one from the file list. Set the *Files of type:* field to \*.nci.  
 4. Click the **Open** Button.

**Note** Another PLC Setup (settings in the Change PLC Dialog Box) will be required when opening a project file created with CX-Position version 1.0 on CX-Position version 2.□ (Refer to 3-2 *Adding and Deleting PLCs* for details.)  
 Project files saved from CX-Position version 2.□ cannot be read by

CX-Position version 1.0. If the **Save Project** command is executed after a project file of CX-Position version 2.1 was read by CX-Position version 2.0, parameter settings available only on CX-Position version 2.1 will not be saved in the project file.

To prevent project files from being overwritten, save project files using the **Save Project AS** command. (Refer to 5-1 *Saving Projects* for details.)

## 5-2-2 Importing C200HW-NC□□□ NC Settings

C200HW-NC□□□ data created using the SYSMAC-NCT can be imported as NC project data.

- 1,2,3... 1. Select **File - Import**.

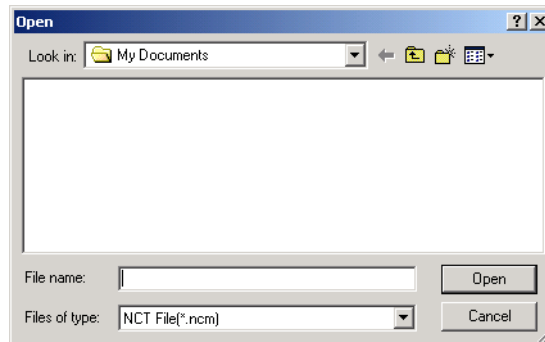

2. From the *Look in* drop-down list, select the drive and folder to which the file to be imported was saved.
3. Enter the file name, or select one from the file list. Set the *Files of type* field to \*.ncm.
4. Click the **Open** Button.





# SECTION 6

## Transferring and Verifying Data

This section provides information on data transfer and verification operations between the CX-Position and Position Control Units, and about operations for writing data transferred to Position Control Units into the Position Control Unit flash memory.

Connect the computer to the PLC with a Connecting Cable and confirm that you are online before attempting to transfer or verify data or write data to the flash memory. (Refer to 2-2 *Connecting to a PLC*.)

6-1	Default Configurations for Connecting Online. . . . .	72
6-1-1	CPU and Position Control Units Default Configuration . . . . .	72
6-2	Setting and Changing Communications Specifications . . . . .	72
6-2-1	Connecting Directly to PLCs . . . . .	72
6-2-2	Connecting to PLCs on Networks . . . . .	73
6-3	Downloading Data . . . . .	75
6-4	Uploading Data . . . . .	76
6-4-1	Uploading Data. . . . .	76
6-4-2	Automatic NC Searches . . . . .	77
6-5	Verifying Data . . . . .	78
6-6	Writing Data to Flash Memory . . . . .	80

## 6-1 Default Configurations for Connecting Online

Online connection enables using the following CX-Position software functions.

- Download to NC
- Upload from NC
- Verify
- Write Flash Memory
- Monitor
- Monitor Units
- Monitor NC Operating Memory Area
- Monitor NC Operating Data Area
- View NC Error Log

The following PLC settings are required to connect the CX-Position software online to a PLC using serial communications (with the Host Link protocol or Toolbus) and execute the functions in the previous list.

### 6-1-1 CPU and Position Control Units Default Configuration

- 1,2,3...
1. Set the Position Control Unit's unit number using the rotary switch on the front panel.
  2. Set the DIP switch on the CPU Unit or Controller Section of the NSJ Controller.
    - a) When Communications Are Established with Toolbus
      - When using a peripheral port, set pin 4 to OFF, or set pin 4 to ON and perform PLC Settings (set the PLC Setup address 144 to 0400 Hex).
      - When using an RS-232C port, set pin 5 to ON, or set pin 5 to OFF and perform PLC Settings (set the PLC Setup address 160 to 0400 Hex).
    - b) When Communications Are Established with SYSMAC WAY (Host Link)
      - When using a peripheral port, set pin 4 to ON, or perform the PLC Settings (set the PLC Setup address 144 to 0000 Hex (default setting)).
      - When using an RS-232C port, set pin 5 to OFF, or perform the PLC Settings (set the PLC Setup address 160 to 0000 Hex (default setting)).
  3. Create the I/O tables (using the CX-Programmer or Programming Console).

## 6-2 Setting and Changing Communications Specifications

### 6-2-1 Connecting Directly to PLCs

When connecting directly to a PLC through a Toolbus or Host Link connection, the communications specifications have been set when the PLC was added. For details, see *3-2 Adding and Deleting PLCs*. To change or check the communications specifications, use the **Properties** settings.

- Note**
1. When using the CX-Position simultaneously with the CX-Programmer, the same communications setting should be used. If different settings are made, a communications error will occur.
  2. When using the CX-Position simultaneously with Programming Devices such as the CX-Programmer, the CX-Protocol, etc., a communications er-

ror (timeout) may occur. In this case, increase the value set for the response timeout in the network settings.

On the project workspace, move the cursor on the PLC to which the applicable Position Control Unit has been registered and right-click it. Select **Properties** from the menu.

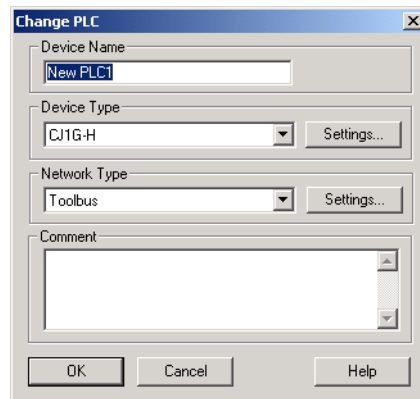

Change the setting, if needed, and click the **OK** Button. For details of transferring, verifying, and writing to the flash memory, see 6-3 *Downloading Data*, 6-4 *Uploading Data*, 6-5 *Verifying Data*, 6-6 *Writing Data to Flash Memory*.

## 6-2-2 Connecting to PLCs on Networks

This section explains the setting method to establish communications with PLCs on networks. By this setting, it becomes possible to use data created or set with CX-Position for the Position Control Units mounted on the PLC in a network. Additionally, all the online functions such as transferring, verifying, writing to the flash memory, monitoring, etc. of data on Position Control Units can be executed for a Position Control Unit on a network.

The setting method to establish communications with the PLC on a network will be explained using the following system configuration example.

The CX-Position is connected online to PLC100 on the network through PLC000. The network type Toolbus is used.

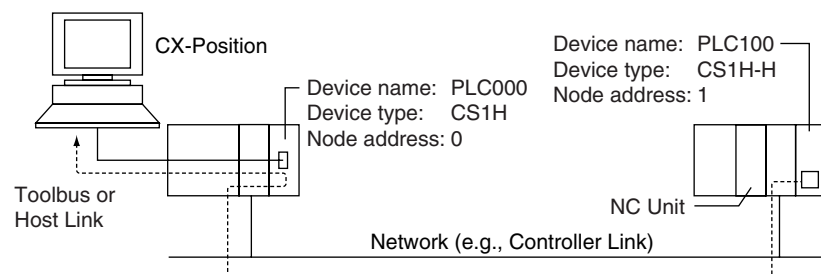

In this example, PLC000 has been registered in the project. Network settings are performed when adding PLC100 to the project.

- 1,2,3... 1. Select the **Project** Icon in the project workspace, and click  in the toolbar or select **Edit - New PC**. The Add PLC Dialog Box will be displayed. Set the device name, device type, and network type as shown below.

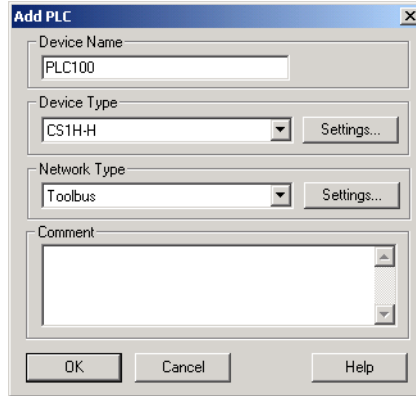

2. Click the **Settings** Button on the right of the Network Type Selection Box. The content of the Network Tab Page in the Network Settings [Toolbus] Dialog Box will be displayed. Set them as shown below.

For local network communications, set 0.

Use the default setting normally. When communications are established through 2 or more types of networks, use the shorter frame length.

Set 1 for node address.

If timeouts occur, set a longer response time-out time.

3. Click the **Driver** Tab. Set the contents shown below. Setting the port to PLC100 is not necessary here. Set the same baud rate for between the CX-Position and PC000. When using a CS-series CPU Unit, and selecting the Baud Rate Auto-Detect option, communications will be established with the baud rate set here regardless of the communications settings on the CPU Unit. In this example, communications port 1 on the personal computer is connected to the RS-232C port on PLC000 with a cable, and pin 5 on the DIP switch on the CPU Unit is set to ON.

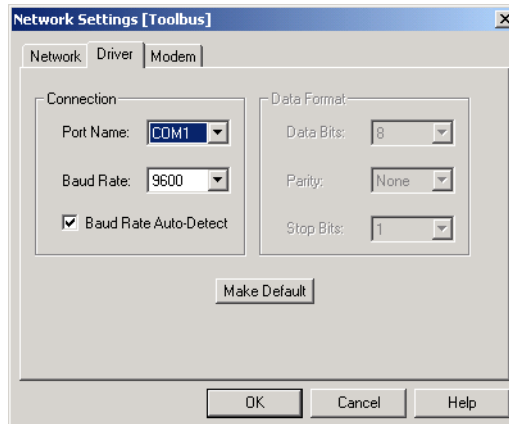

4. Click the **OK** Button. The Add PLC Dialog Box will be displayed again. Click the **OK** Button. PLC100 will be added to the project.
5. Add an applicable Position Control Unit to PLC100. For details, see 3-3 *Adding and Deleting Position Control Units*.
6. Create data for the added Position Control Unit. This completes the setting. For details of transferring, verifying, and writing data to the flash memory, see 6-3 *Downloading Data*, 6-4 *Uploading Data*, 6-5 *Verifying Data*, 6-6 *Writing Data to Flash Memory*.

## 6-3 Downloading Data

Use the following procedure to download edited project data from the (CX-Position) computer to the Position Control Unit.

- 1,2,3... 1. On the project tree, select the Position Control Unit to be downloaded to.
2. Select **Online - Transfer to NC**.

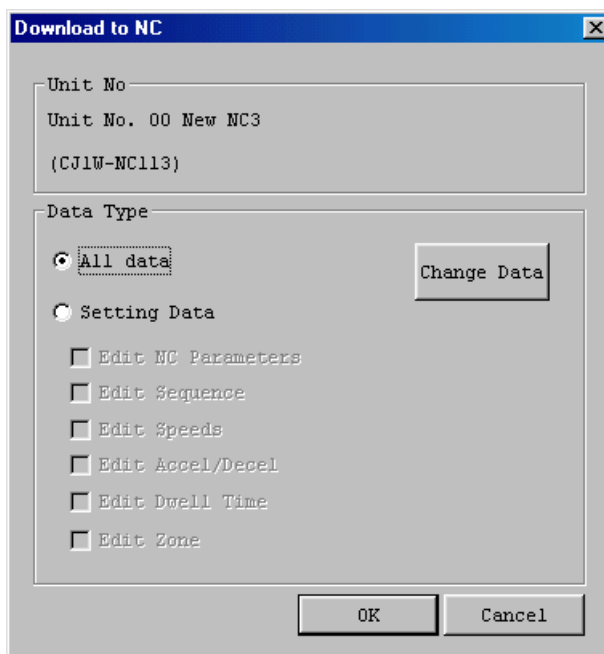

3. Select the data to be downloaded under *Data Type*. To download all data, select *All Data*. To designate specific data to be downloaded, select *Setting Data* and then the specific data. Clicking the **Change Data** Button will select only the data that has been changed.
4. Click the **OK** Button. (Click the **Cancel** Button during data loading to stop the download.)

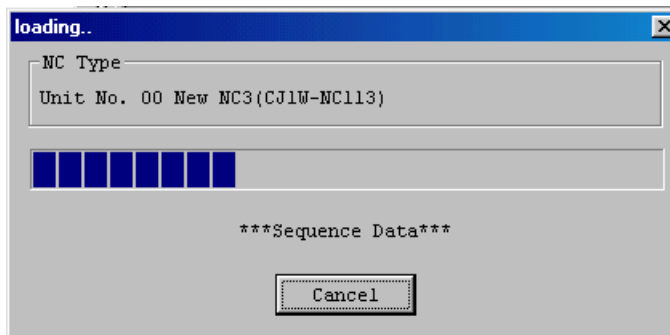

- When download is complete, *Transfer successful; Write flash memory?* will be displayed.

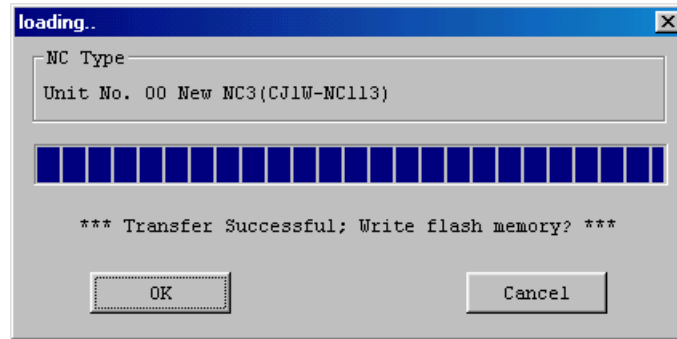

- Click the **OK** Button. If the **Cancel** Button is clicked, the downloaded data is valid until the PLC is switched OFF. When the PLC is switched ON again, last data written to the flash memory will be read.

**Note** When using the modem connection, the connection is cut off once after completion of downloading data. The connection is then automatically reestablished, and data is written to the Flash Memory.

## 6-4 Uploading Data

### 6-4-1 Uploading Data

Use the following procedure to upload Position Control Unit data to the (CX-Position) computer.

- 1,2,3... On the project tree, select the Position Control Unit to be uploaded from.
- Select **Online - Transfer from NC**.



- Select the data to be uploaded under *Data Type*. To upload all data, select *All Data*. To designate specific data to be uploaded, select *Setting Data* and then the specific data.

4. Click the **OK** Button.

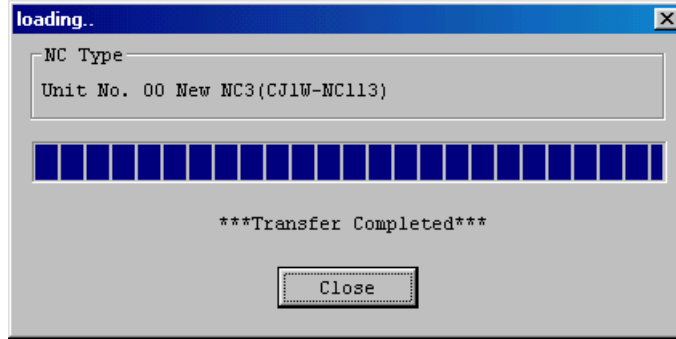

### 6-4-2 Automatic NC Searches

When online, Position Control Units under a project's specified PLC can be searched for automatically by uploading data from all the Position Control Units installed on the PLC to be connected online. All of the data on all the specified PLC's Position Control Units can also be uploaded to the project.

- 1,2,3... 1. Select **Edit - New PLC**, or right-click and select **New PLC** from the pop-up menu, to create a PLC.
2. Select the PLC on the project tree and select **Online - Automatic NC Search**.

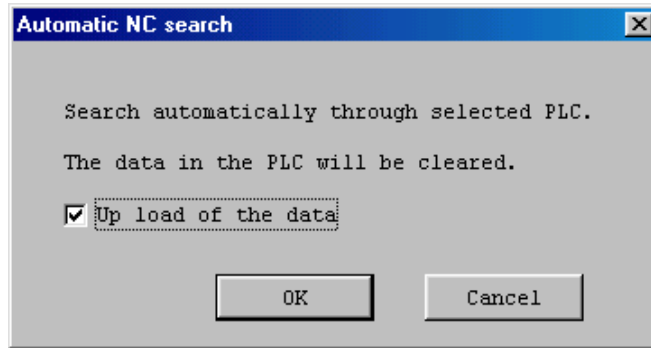

3. To upload all Position Control Unit data, select the checkbox.
4. Click the **OK** Button. The project will be automatically searched for. The following window will be displayed if data is uploaded.

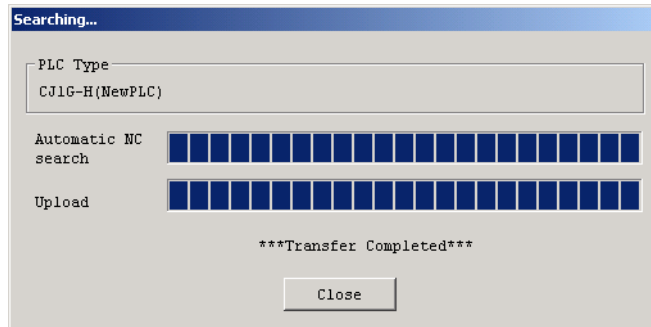



The following window will be displayed if data is not uploaded.

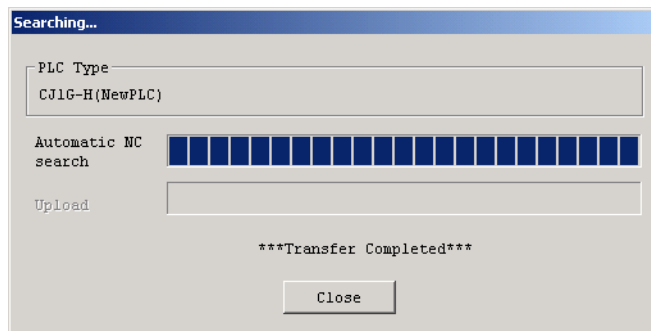

## 6-5 Verifying Data

Use the following procedure to verify CX-Position data at the computer and Position Control Unit data.

- 1,2,3...
1. On the project tree, select the Position Control Unit for verification.
  2. Select **Online - Verify**.

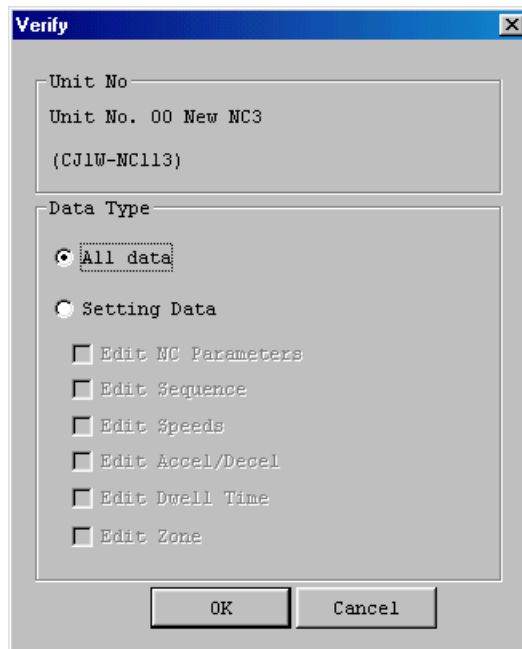

3. Under *Data Type*, select the data to be verified. To verify all data, select *All Data*. To designate specific data to be verified, select *Setting Data*, and then the specific data.
4. Click the **OK** Button. (Click the **Cancel** Button during verification to stop the verification process.)

- The following window will be displayed when verification has been completed. Click the **Close** Button to end verification.

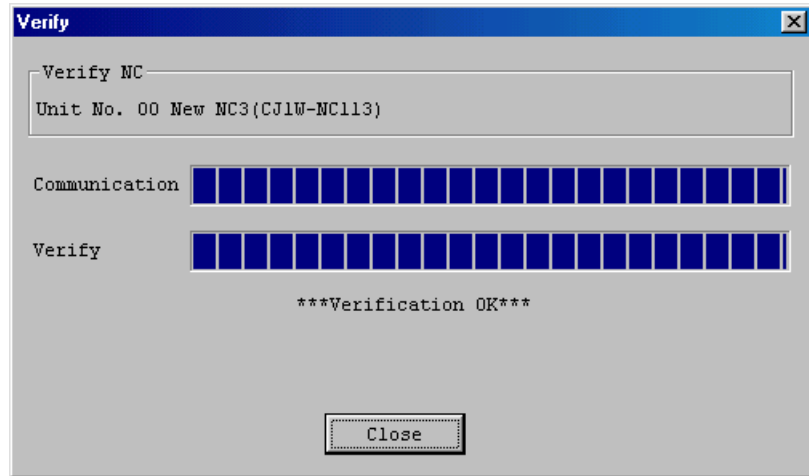

The following window will be displayed if there is a failure during the verification process. Click the **Close** Button to halt verification.

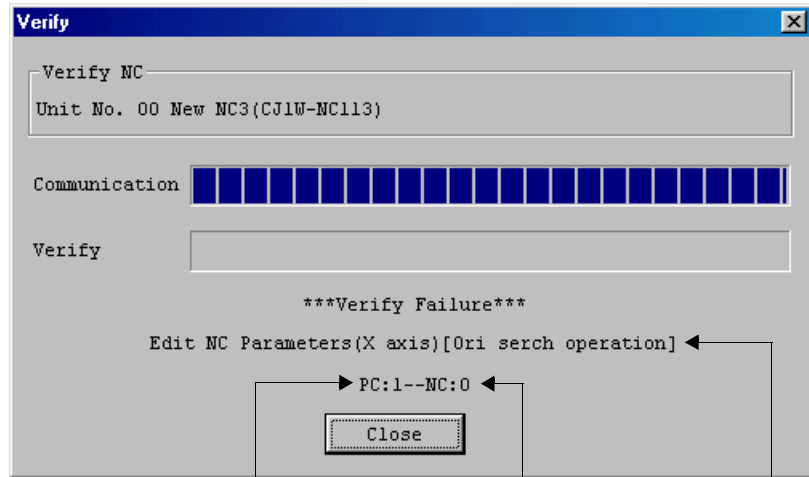

Setting on CX-Position is 1.

Setting in Position Control Unit is 0.

Shows that the settings on the CX-Position and in the Unit did not match with each other.

## 6-6 Writing Data to Flash Memory

Use the following procedure to write all, or specified, data in the Position Control Unit to flash memory.

**⚠ Caution** Back up the data to flash memory after transferring parameters or other data to the Position Control Unit. If parameters and other data are not backed up to flash memory, settings will revert to their previous values the next time power is turned ON, possibility resulting in incorrect operation

- 1,2,3...**
1. On the project tree, select the Position Control Unit for flash memory writing.
  2. Select **Online - Write Flash Memory**.

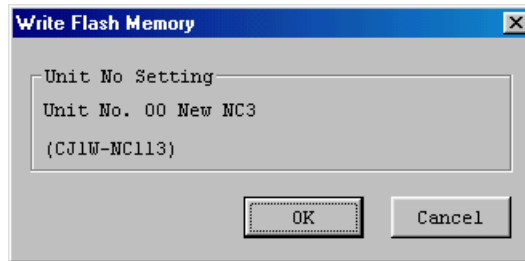

3. Click the **OK** Button.



4. Click the **OK** Button.

# SECTION 7

## Monitoring Position Control Units

This section provides information about monitoring Position Control Units. The Position Control Unit's current positions, error codes, and status are displayed on the *NC Monitor*. *Monitor Units* are also available, displaying sequence numbers and current positions for up to four Units simultaneously. Operating memory area monitoring, operating data area monitoring, and Position Control Unit error logs can also be displayed. For details on NC error log display, refer to *11-1 Position Control Unit Error Logs*.

Connect the computer to the PLC with a Connecting Cable and confirm that you are online before attempting to monitor a Position Control Unit. (Refer to *2-2 Connecting to a PLC*.)

7-1	Monitoring Position Control Units . . . . .	82
7-2	Multiple Unit Monitoring . . . . .	83
7-3	Operating Memory Area Monitoring . . . . .	84
7-4	Operating Data Area Monitoring . . . . .	84

## 7-1 Monitoring Position Control Units

Use the following procedure to display Position Control Unit present positions, error codes, sequence numbers, and I/O status on the *NC Monitor*.

- 1,2,3... 1. On the project tree, select the Position Control Unit to be monitored and select **Online - Monitor**. If another Position Control Unit is to be monitored after NC monitoring has been started, select the new Position Control Unit from the *Unit No.* field.

Example: The following will be displayed as the 4-axis NC Monitor Window.

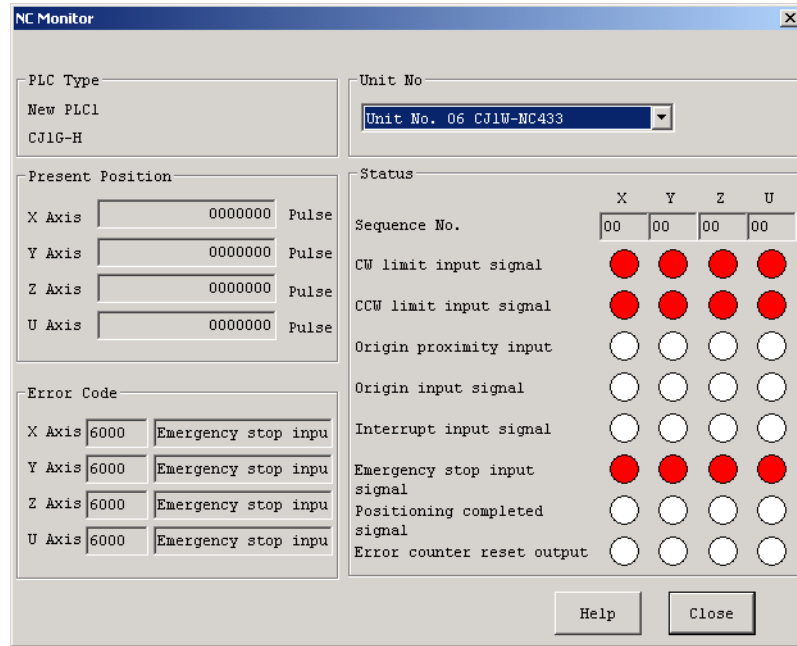

The present position of each axis is shown under *Present Position*; the error code number and description are shown under *Error Code*; and the sequence number and I/O status of each axis are shown under *Status*. A red light indicates that an I/O signal is ON.

For error details, refer to the relevant Position Control Unit *Operation Manual*, or click the **Help** Button.

**Note** Press the Ctrl+v Keys in the NC Monitor Window to display the version of the embedded system software in the Position Control Unit being used. (See the following diagram.) Check the version through this operation. Refer to *Unit Versions of Position Control Units* on page vi for the functions provided for each internal system software version of the Position Control Units.

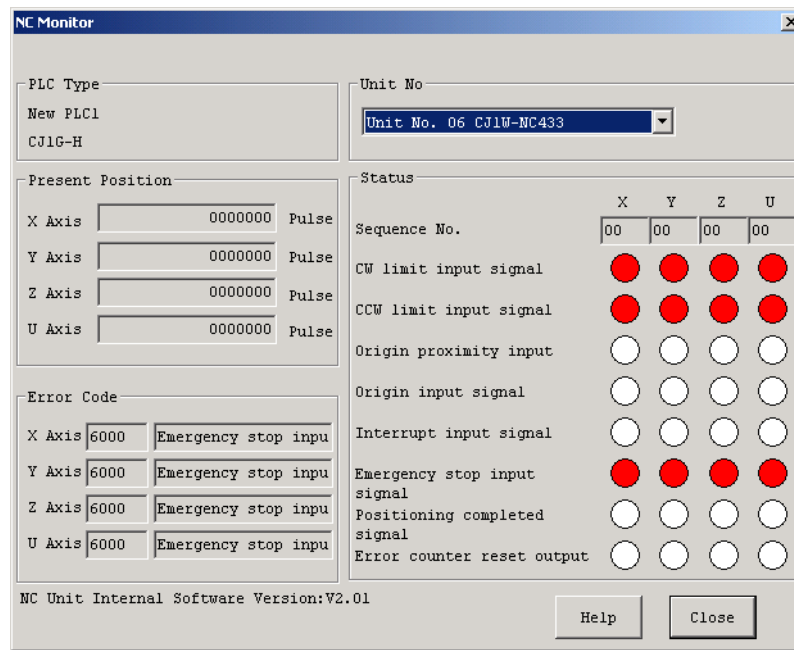

## 7-2 Multiple Unit Monitoring

Use the following procedure to monitor the status of up to four Position Control Units simultaneously.

- 1,2,3... 1. On the project tree, select an PLC or NC, and then select **Online - Monitor Units**. After starting Unit monitoring, the Units selected for monitoring can be changed using the window's four drop-down lists.

Example: The following will be displayed as the 4-axis Position Control Unit Monitor Units Window.

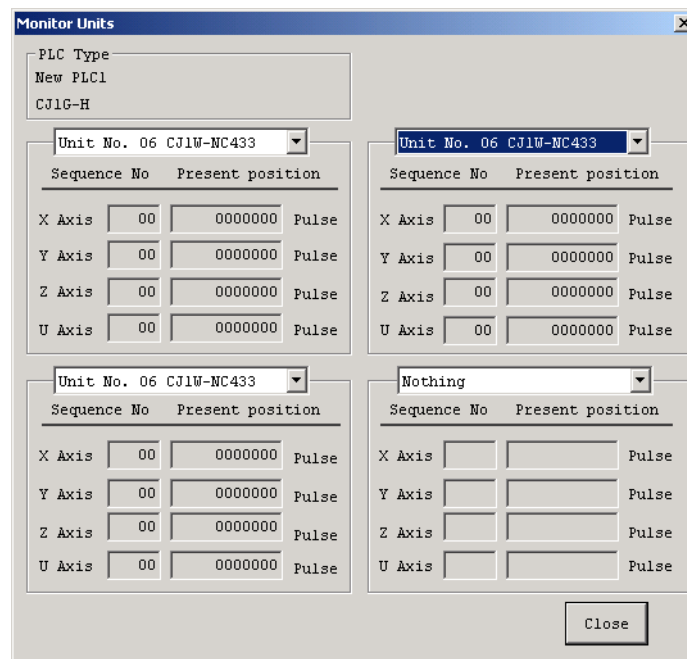

The sequence number and current position for each axis are displayed.

### 7-3 Operating Memory Area Monitoring

Use the following procedure to monitor the operating memory area (Special I/O Unit words allocated in the CIO Area) allocated to the PLC.

- 1,2,3...
1. On the project tree, select the Position Control Unit for operating memory area monitoring.
  2. Select **Online - Online Monitor NC Operating Memory Area**.
  3. Select either *Automatic* or *Manual* to start monitoring. *Automatic* continues monitoring until the **Stop Monitor** Button is clicked. *Manual* refreshes the monitor window contents.

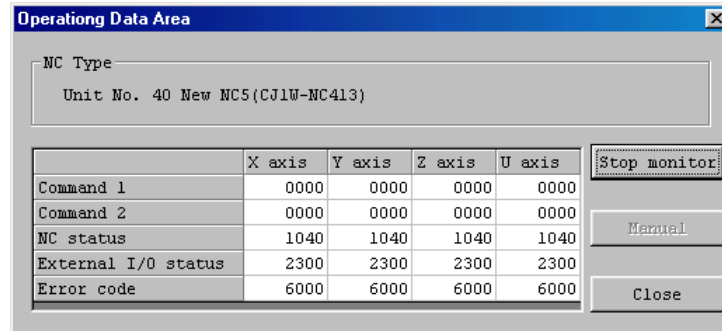

The following table shows the operating memory area words that are displayed.

Data	Allocated words						
	NC1□3	NC2□3		NC4□3			
	X axis	X axis	Y axis	X axis	Y axis	Z axis	U axis
Command 1	n	n	n+2	n	n+2	n+4	n+6
Command 2	n+1	n+1	n+3	n+1	n+3	n+5	n+7
NC status	n+2	n+4	n+7	n+8	n+11	n+14	n+17
External I/O status	n+3	n+5	n+8	n+9	n+12	n+15	n+18
Error codes	n+4	n+6	n+9	n+10	n+13	n+16	n+19

Refer to the CX-Position Online Help or the *Operation Manual* for the Position Control Unit for details on bit allocations.

### 7-4 Operating Data Area Monitoring

Use the following procedure to monitor the operating data area (Special I/O Unit words allocated in the DM Area or custom DM/EM Area) allocated to the PLC.

- 1,2,3...
1. On the project tree, select the Position Control Unit for operating data area monitoring.
  2. Select **Online - Online Monitor NC Operating Data Area**.

3. Select either *Automatic* or *Manual* to start monitoring. *Automatic* continues monitoring until the **Stop Monitor** Button is clicked. *Manual* refreshes the monitor window contents.

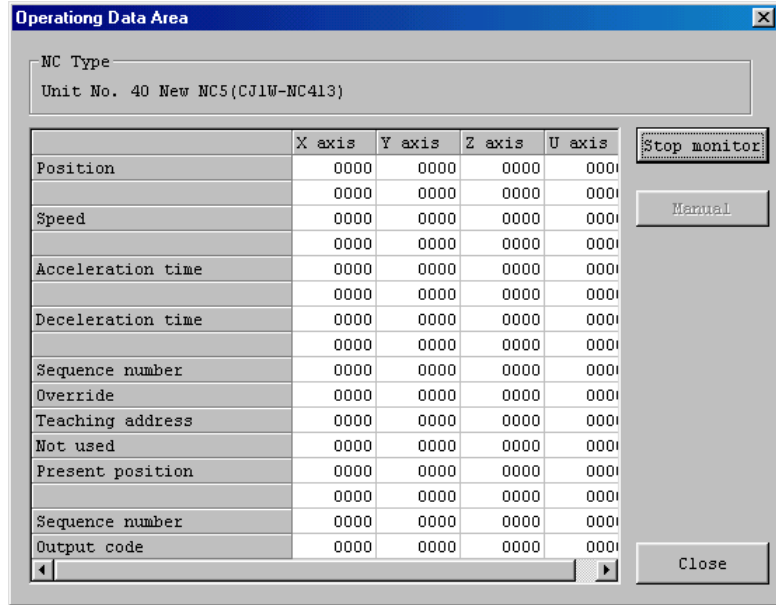

Data	Allocated words (See note 1.)						
	NC1□3	NC2□3		NC4□3			
	X axis	X axis	Y axis	X axis	Y axis	Z axis	U axis
Positions	I+8	I+8	I+20	I+8	I+20	I+32	I+44
	I+9	I+9	I+21	I+9	I+21	I+33	I+45
Speeds	I+10	I+10	I+22	I+10	I+22	I+34	I+46
	I+11	I+11	I+23	I+11	I+23	I+35	I+47
Acceleration times	I+12	I+12	I+24	I+12	I+24	I+36	I+48
	I+13	I+13	I+25	I+13	I+25	I+37	I+49
Deceleration times	I+14	I+14	I+26	I+14	I+26	I+38	I+50
	I+15	I+15	I+27	I+15	I+27	I+39	I+51
Sequence numbers	I+16	I+16	I+28	I+16	I+28	I+40	I+52
Overrides	I+17	I+17	I+29	I+17	I+29	I+41	I+53
Teaching addresses	I+18	I+18	I+30	I+18	I+30	I+42	I+54
Not used	I+19	I+19	I+31	I+19	I+31	I+43	I+55
Present positions	I+20	I+32	I+36	I+56	I+60	I+64	I+68
	I+21	I+33	I+37	I+57	I+61	I+65	I+69
Sequence numbers	I+22	I+34	I+38	I+58	I+62	I+66	I+70
Output codes	I+23	I+35	I+39	I+59	I+63	I+67	I+71

- Note**
1. The first word address depends on the setting in words m and m+1 of the common parameters (where m = D20000 + 100 × unit number) Refer to the *Operation Manual* for the Position Control Unit for details.
  2. Refer to the *Operation Manual* for the Position Control Unit for details on operating data area.





# SECTION 8

## Test Run Operation

This section describes the test run operations for each axis.

8-1	Test Run Settings.....	88
8-2	Test Run .....	88

## 8-1 Test Run Settings

The following allocations are set in the test run settings.

- RUN signal allocation
- Drive alarm reset signal allocation

### Displaying the JOG Operation Settings Window

- 1,2,3...
1. On the project tree, select the Position Control Unit to execute the test run.
  2. Select **Online - Test Run Settings**.
  3. The Test Run Settings Window will be displayed.

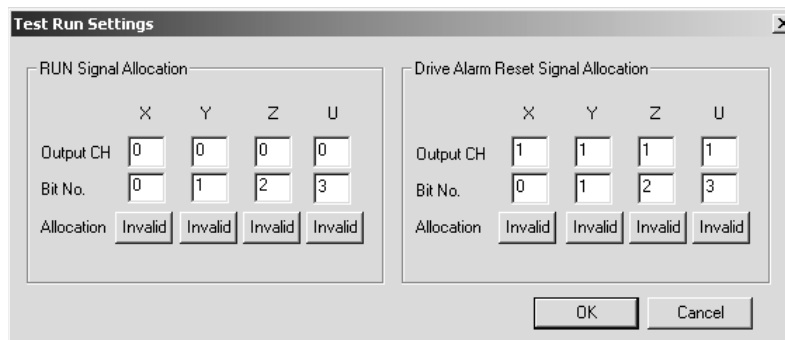

### Closing the Test Run Settings Window

Click the **OK** Button to reflect the edited settings. Click the **Cancel** Button to not reflect the edited settings.

### Test Run Settings

Set the output words and bit numbers to allocate the RUN signals and drive alarm reset signals. Then, click the **Invalid** Button of each axis. **Valid** will be displayed to show that the allocation is valid.

## 8-2 Test Run

The following operations are possible in the test run.

- Turning ON/OFF the RUN signal for each axis
- Resetting alarms for each axis
- JOG operations
- Direct operations
- Origin searches

### Displaying the Test Run Window

- 1,2,3...
1. On the project tree, select the Position Control Unit to execute the test run.
  2. Select **Online - Test Run**. The following warning dialog box will be displayed. Read the contents of the warning carefully. Click the **OK** Button only after confirming safety.

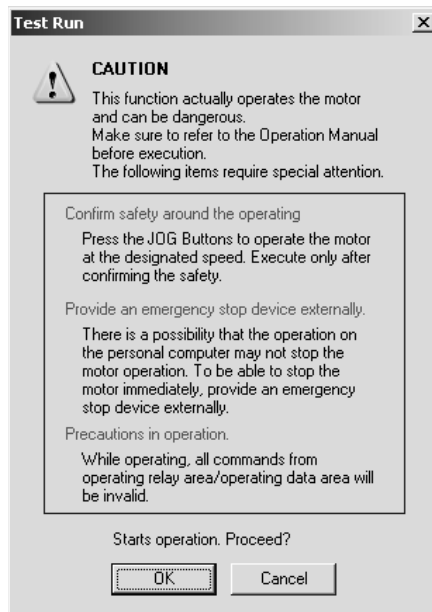

3. The Test Run Window will be displayed.

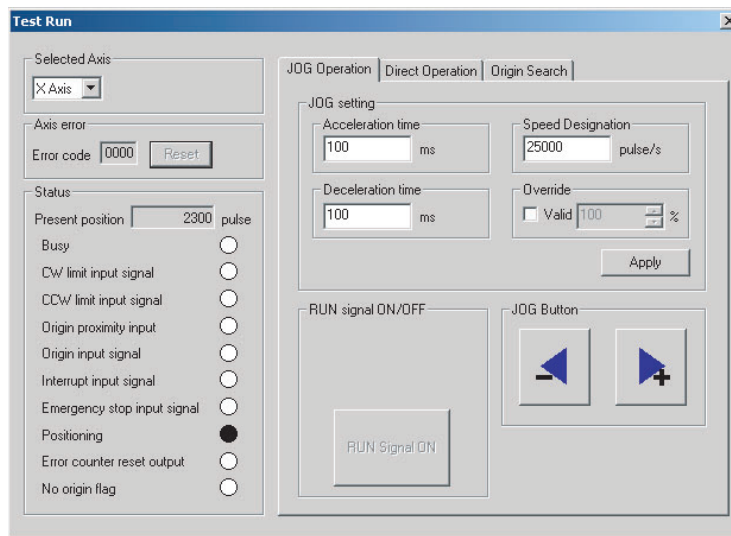

- Note**
- (1) Operations can be executed with a Position Control Unit with unit version 2.3 (with embedded software version 2.3) or later. To confirm the unit version of the Position Control Unit, refer to *Unit Versions of Position Control Units* on page vi.
  - (2) Operations can be executed when the PLC is in PROGRAM mode. Execute JOG operations only after changing the PLC to PROGRAM mode using the CX-Programmer or Programming Console.

### Closing the Test Run Window

Click the **Close** Button at the right top corner of the Test Run Window. If a RUN signal has been turned ON, it will remain ON when the window closes.

## Executing JOG Operations

- Note**
- (1) Executing a JOG operation will operate the motor at the designated speed. Execute these operations only after confirming safety.
  - (2) The operation on the personal computer may not stop the motor. Provide an emergency stop device externally to enable stopping the motor immediately at any time.

- 1,2,3...**
1. Click the **JOG Operation Tab**.

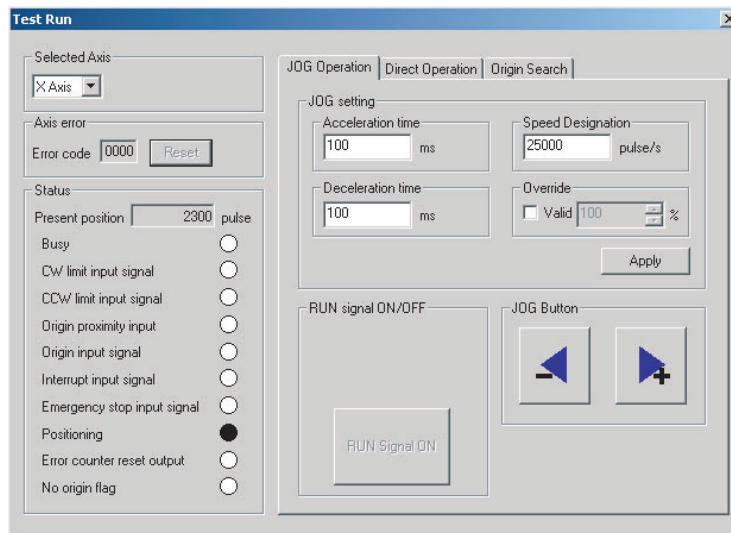



2. Select the axis to be jogged.
3. If the RUN signal allocation for the axis is set to Valid in the Test Run Settings Window (refer to 8-1 Test Run Settings), the **RUN Signal ON** Button can be used. (If the RUN signal allocation is set to Invalid, the **RUN Signal ON** Button will be disabled as shown in the above window.) Click the **RUN Signal ON** Button to turn ON the RUN signal.
4. Enter the acceleration time, deceleration time, speed, and override value in the JOG Setting Area, and then click the **Apply** Button. Clicking this button is required before executing the JOG operation.
5. Execute the JOG operation with the JOG Buttons.
6. If an error occurs in the axis, the error code will be displayed. Click the **Reset** Button in the *Axis Error Area* to clear the error. If the drive alarm reset signal is allocated in the Test Run Settings Window (refer to 8-1 Test Run Settings), the drive alarm will be cleared as well.

## Executing Direct Operations

- Note**
- (1) Executing a direct operation will operate the motor at the designated speed. Execute direct operations only after confirming safety.
  - (2) The operation on the personal computer may not stop the motor. Provide an emergency stop device externally to enable stopping the motor immediately at any time.

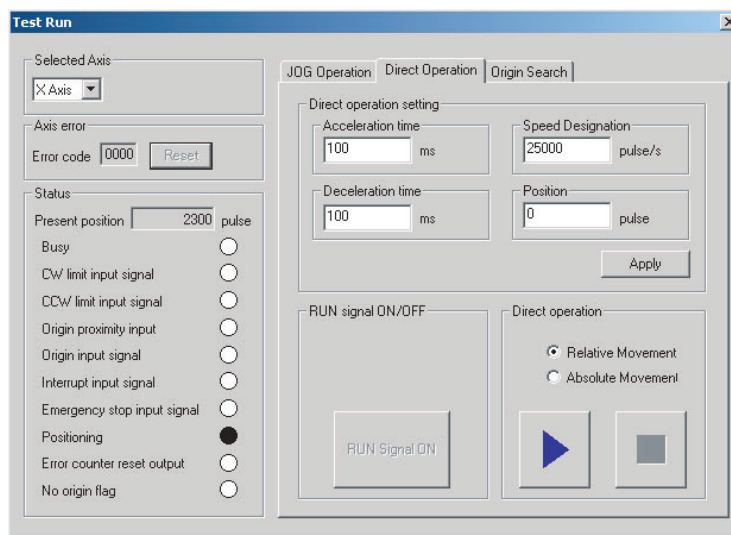
- 1,2,3...**
1. Click the **Direct Operation Tab**.





2. Select the axis for which to execute the direct operation.
3. If the RUN signal allocation is set to Valid in the Test Run Settings Window (refer to 8-1 Test Run Settings), the **RUN Signal ON** Button can be used. (If the RUN signal allocation is set to Invalid, the **RUN Signal ON** Button will be disabled as shown in the above window.) Click the **RUN Signal ON** Button to turn ON the RUN signal.
4. Enter the acceleration time, the deceleration time, the desired speed, and the desired position in the Direct Operation Setting Area, and then click the **Apply** Button. Clicking this button is required before executing the direct operation.
5. Select the *Absolute Movement* or *Relative Movement* Option.
6. Click the  Button to execute the direct operation.
7. Click the  Button to stop the direct operation.

## Executing Origin Searches

- Note**
- (1) Executing an origin search will operate the motor at the designated speed. Execute these operations only after confirming safety.
  - (2) The operation on the personal computer may not stop the motor. Provide an emergency stop device externally to enable stopping the motor immediately at any time.

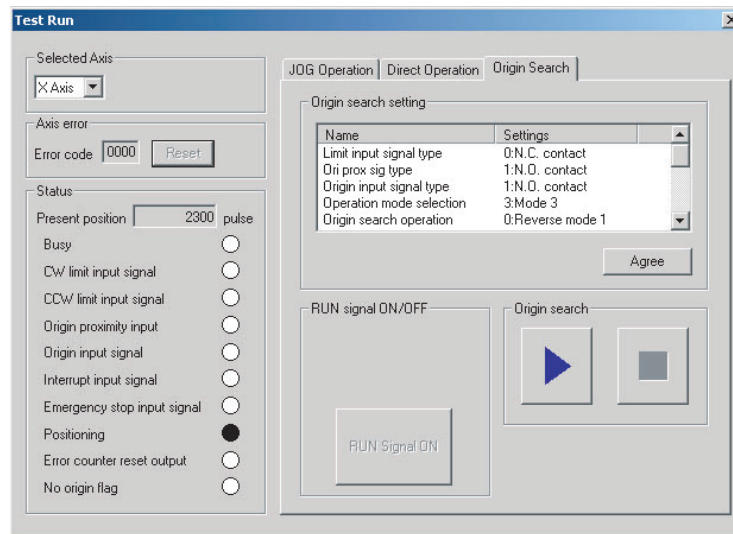
- 1,2,3... 1. Click the **Origin Search** Tab.



2. Select the axis for which to execute the origin search.
3. If the RUN signal allocation is set to Valid in the Test Run Settings Window (refer to 8-1 Test Run Settings), the **RUN Signal ON** Button can be used. (If the RUN signal allocation is set to Invalid, the **RUN Signal ON** Button will be disabled as shown in the above window.) Click the **RUN Signal ON** Button to turn ON the RUN signal.
4. Check the parameter values set in the Origin Search Setting Area. Click the **Agree** Button if they are correct. Clicking this button is required before executing the origin search.  
  
Click the  Button to execute the origin search.  
The origin search will be executed according to the parameters set in the Position Control Unit.
5. Click the  Button to stop the origin search.

# SECTION 9

## Error Counter Reset Output

This section describes the error counter reset output.

9-1 Error Counter Reset Output .....	94
--------------------------------------	----



## 9-1 Error Counter Reset Output

The Error Counter Reset Output Dialog Box can be used to turn the error counter reset output signal ON and OFF.

### Displaying the Error Counter Reset Output Window

- 1,2,3...
1. On the project tree, select the Position Control Unit for which to execute the error counter reset output.
  2. Select **Online - Error Counter Reset Output**.
  3. The following warning dialog box will be displayed. Read the contents of the warning carefully. Click the **OK** Button only after confirming safety.

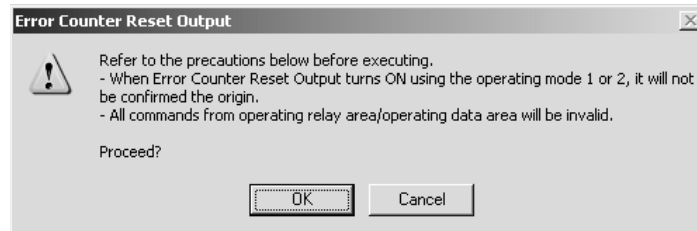

4. The Error Counter Reset Output Dialog Box will be displayed.

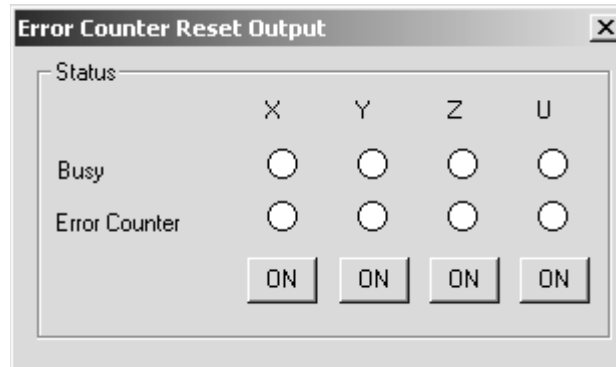

- Note**
- (1) ON/OFF control of the error counter reset output signal can be executed with Position Control Unit with unit version 2.3 (with embedded software version 2.3) or later.  
To confirm the unit version of the Position Control Unit Version, refer to the *Unit Versions of Position Control Units* on page vi.
  - (2) ON/OFF control of the error counter reset output can be executed when the PLC is in PROGRAM mode. Execute the operation after changing the PLC to PROGRAM mode using the CX-Programmer or Programming Console.

### Closing the Error Counter Reset Output Window

Click the **Close** Button at the right top corner of the error counter reset output Window. The error counter reset output will be turned OFF for all axes.

### ON/OFF Control of the Error Counter Reset Output Signal

- 1,2,3...
1. Click  of the desired axis to turn ON the error counter reset output signal.
  2. Click  to turn OFF the error counter reset output signal.

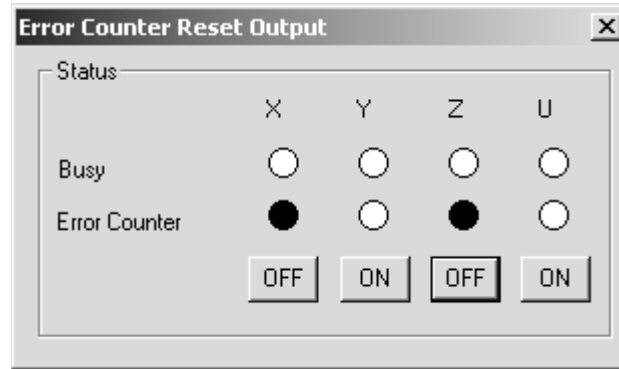

**Note** If the axis is in busy status, ON/OFF control of error counter reset output signal cannot be executed.



# SECTION 10

## Printing Data

This section provides information about printing data.

10-1 Printing Data .....	98
--------------------------	----

## 10-1 Printing Data

Use the following procedure to print all of the data or specific data. For *Edit Sequence*, a specified range of data numbers can be printed.

- 1,2,3...
1. On the project tree, select the data or Position Control Unit for printing.
  2. Select **File - Print**.

Example: The following window will be displayed for a 4-axis Position Control Unit.

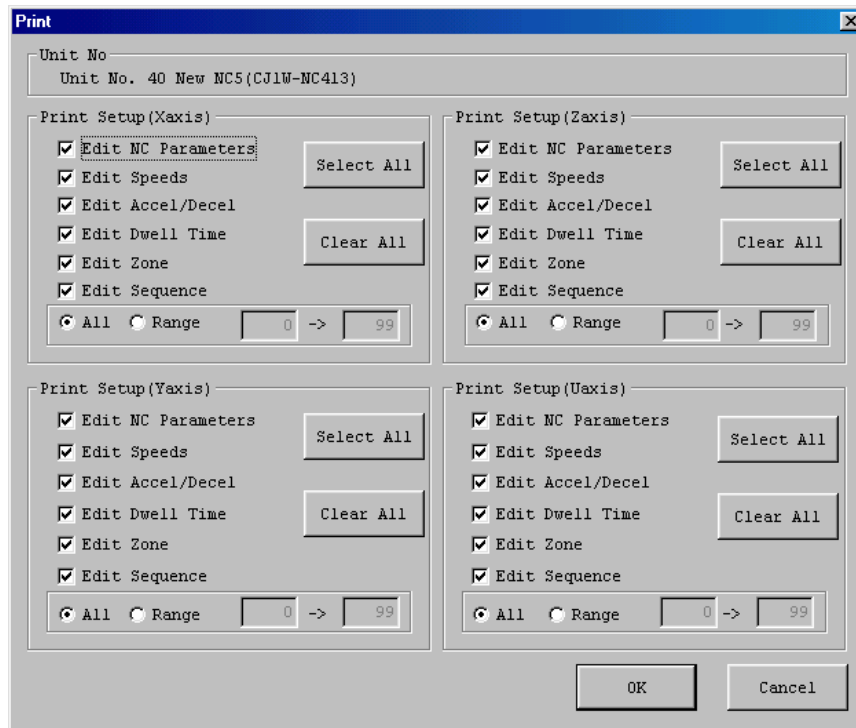

For a 2-axis Unit, the X axis and Y axis will be shown; for a 1-axis Unit, just the X axis will be shown. After selecting the Position Control Unit, select **Print** to display the window with all the checkboxes selected. After selecting the data, select **Print** to display the window with just the specified checkboxes selected.

3. To print all data, click the **Select All** Button. To print specific data, select their checkboxes. *All* is the default selection for the *Edit Sequence* checkbox. To print a specified range, select *Range* Option and enter the start and end data numbers.

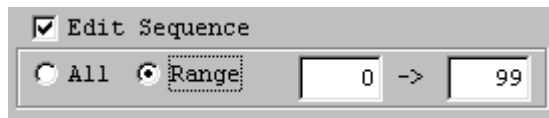

4. Click the **OK** Button.

The following two tables represent print examples.

• Acceleration/Deceleration Data

No.	X axis		Y axis		Z axis		U axis	
	Accel.	Decel.	Accel.	Decel.	Accel.	Decel.	Accel.	Decel.
+1	1000	2000	10000	8000	300	100	400	200
+2	2000	4000	12000	10000	600	200	800	400
+3	3000	6000	14000	12000	900	300	1200	600
+4	4000	8000	16000	14000	1200	400	1600	0
+5	5000	10000	18000	16000	1500	500	2000	0
+6	6000	12000	20000	18000	1800	600	2400	0
+7	7000	14000	22000	20000	2100	700	2800	0
+8	8000	16000	24000	22000	2400	800	3200	0
+9	9000	18000	26000	24000	2700	900	3500	0

• Zone Data

		X axis	Y axis	Z axis	U axis
Zone 0	CW	536870911	268435455	805306367	132417727
Zone 0	CCW	-536870911	-268435455	-805306367	260046849
Zone 1	CW	25165823	8388607	536870911	7340031
Zone 1	CCW	8388608	524288	-536870911	2097151
Zone 2	CW	4194303	6291455	8388607	655359
Zone 2	CCW	-4194303	-6291455	-8388607	-655359



# SECTION 11

## Error Logs and Troubleshooting

This section provides information about Position Control Unit error log displays and troubleshooting.

11-1	Position Control Unit Error Logs . . . . .	102
11-1-1	Overview . . . . .	102
11-1-2	To Display Position Control Unit Error Logs . . . . .	102
11-1-3	Troubleshooting . . . . .	102
11-1-4	Command Execution Check . . . . .	106
11-2	Troubleshooting . . . . .	117



## 11-1 Position Control Unit Error Logs

### 11-1-1 Overview

A maximum of 20 Position Control Unit errors can be recorded and displayed. Errors thereafter will replace previous errors, starting with the least recent error.

### 11-1-2 To Display Position Control Unit Error Logs

- 1,2,3... 1. On the project tree, select the Position Control Unit whose error log is to be displayed, and select **Online - View NC Error Log**.

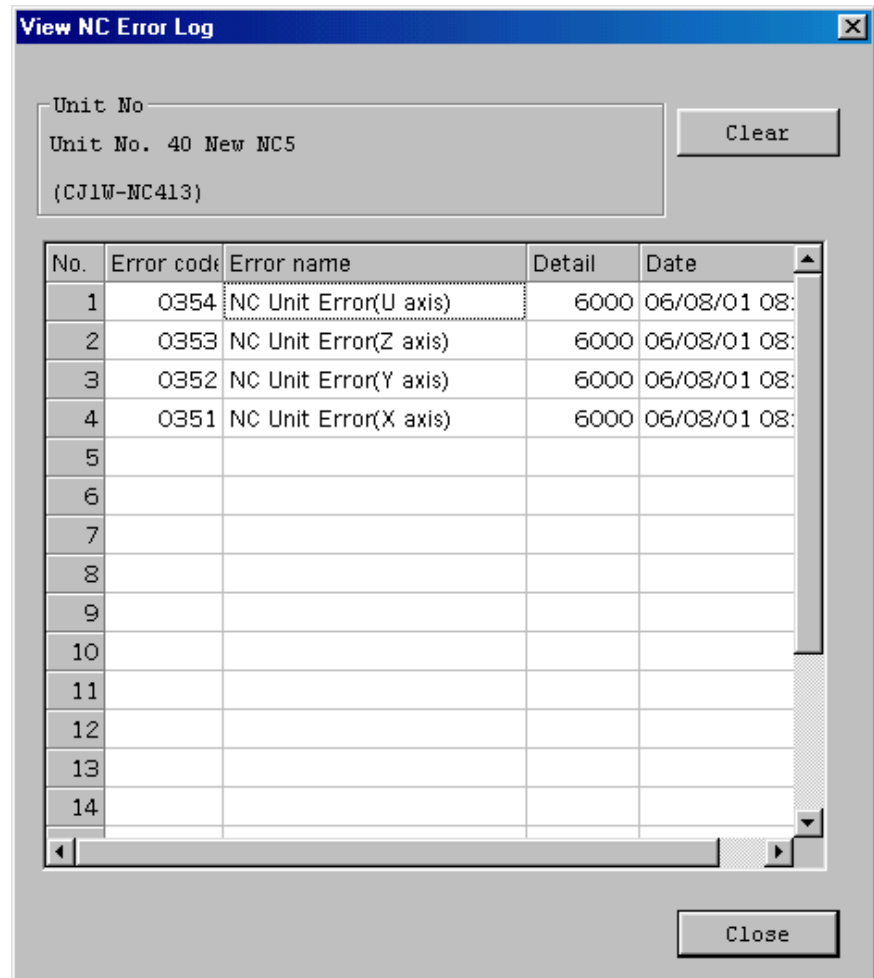

Click the **Clear** Button to clear the error log.

**Note** Error codes 0350 to 0354 are Position Control Unit errors. Position Control Unit error codes will be displayed for them under *Detail*.

### 11-1-3 Troubleshooting

For detailed information on error code causes and remedies, see the section on troubleshooting in the *Operation Manual* of the Position Control Unit, or select **Help - Unit Errors** and refer to **Unit Error Help**.

**Data Check at Startup** The following table shows the errors checked when power is turned ON.

Group	Name	Code	Cause	Remedy
Data destruction	Parameters destruction	0001	When using the axis parameters in the Position Control Unit, the parameters saved in flash memory are lost. It is possible that, while saving to flash memory, the Position Control Unit's power supply was interrupted, there was noise, or there was an error in flash memory.	In this condition, only the data transfer (read and write) and data save operations can be performed. The Position Control Unit's axis parameters and data are all returned to their default values. After transferring the parameters and data for all axes, save the parameters and either reset the power supply, or restart the Unit. If the error persists, it is possible that there is a fault in flash memory, and so it may be necessary to replace the Position Control Unit.
	Data destruction	0002	The following data saved in flash memory will be lost: Zones, positioning sequences, speeds, acceleration/deceleration data, positions, and dwell times. It is possible that, while saving to flash memory, the Position Control Unit's power supply was interrupted, there was noise, or there was an error in flash memory.	
	F-ROM check data destruction	0003	The flash memory error data saved in flash memory is lost (OMRON maintenance data is lost). It is possible that, while saving to flash memory, the Position Control Unit's power supply was interrupted, there was noise, or there was an error in flash memory.	When this error occurs, operation can be continued by performing error reset. Execute the next operation after performing error reset.
Common parameters	Operating data area designation error	0010	The operating data area designation (m) is incorrect. <ul style="list-style-type: none"> <li>• Area designation: Set to a setting other than 00, 0D, or 0E.</li> <li>• Bank designation: Set to a setting not in the range 00 to 0C, when 0E is set for the area designation.</li> </ul>	In this condition, only the data save operations can be performed. All of the axes' parameters and all data will be returned to their default values. After correcting the common parameters, (refer to <i>SECTION 4</i> ), reset the power supply or restart the Position Control Unit.
	Operating data area address designation error	0011	The designation of the beginning word of the operating data area's address (m+1) is outside the settable range.	
	Parameter designation error	0013	The axis parameter designation (m+2) is not set to 00 or 01.	
	Axis designation error	0014	The axis parameter designation (m+2) is set to 01, but 1 is set for an axis other than that for a 1-axis, 2-axis or 4-axis Unit.	
Axis parameters	Response timeout	0020	The axis parameters set in the CPU Unit could not be read to the Position Control Unit.	Increase the cycle monitor time set with CX-Programmer and either reset the power supply or restart the Position Control Unit. If this error occurs again, despite increasing the cycle monitor time, it is possible that there is a fault in the Position Control Unit or somewhere in the PLC. Either replace the whole PLC, or the Position Control Unit.

Group	Name	Code	Cause	Remedy
Initial speed	Initial speed error	1000	The axis parameters' initial speed setting exceeds the maximum speed setting for an axis.	In this condition, only the data transfer (read or write) and data save operations can be performed. All of the axis parameters will be returned to their default values.
	Initial pulse designation error	1001	The initial pulse designation is not set to 0000 or 0001.	
Maximum speed	Maximum speed error	1010	The axis parameters' maximum speed setting is outside the settable range (1 to 500 kpps).	After correcting the appropriate axis parameters, reset the power supply or restart the Position Control Unit.
Acceleration/ deceleration data	Acceleration time error	1310	The axis parameters' origin search acceleration time setting is outside the settable range (0 to 250 s).	
	Deceleration time error	1320	The axis parameters' origin search deceleration time setting is outside the settable range (0 to 250 s).	
	Acceleration/deceleration curve error	1330	The axis parameters' acceleration/deceleration curve setting is not 0 or 1.	
	Positioning monitor time error	1332	The axis parameters' positioning monitor time setting is outside the settable range (0 to 9999 ms).	
Origin search	Origin compensation error	1600	The axis parameters' origin compensation setting is outside the settable range (-1,073,741,823 to 1,073,741,823 pulses).	
	Origin search high speed error	1601	The axis parameters' origin search high speed setting exceeds the axis parameters' maximum speed setting.	
	Origin search proximity speed error	1602	The axis parameters' origin search proximity setting exceeds the axis parameters' maximum speed setting.	
	Origin search speed inconsistent	1603	The axis parameters' origin search high speed setting is less than or equal to the origin search proximity speed setting.	
	Operation mode selection error	1604	The axis parameters' origin search operating mode selection setting is not 0, 1, 2, or 3.	
	Origin search operation error	1605	The axis parameters' origin search operation setting is not 0, 1, or 2.	
	Origin search direction error	1606	The axis parameters' origin search direction is not 0 or 1.	
	Origin detection method error	1607	Even though the axis parameters' origin search operation is not set to single-direction mode, the origin detection method setting is not 0, 1, or 2.	

Group	Name	Code	Cause	Remedy
Backlash compensation	Backlash compensation error	1700	The axis parameters' backlash compensation setting is outside the settable range (0 to 9,999 pulses).	In this condition, only the data transfer (read or write) and data save operations can be performed. All of the axis parameters will be returned to their default values. After correcting the appropriate axis parameters, reset the power supply or restart the Position Control Unit.
	Backlash compensation speed error	1710	The axis parameters' backlash compensation speed setting exceeds the maximum speed setting.	
Software limits	CW software limit error	1800	The axis parameters' CW software limit setting is outside the settable range (-1,073,741,823 to 1,073,741,823).	
	CCW software limit error	1801	The axis parameters' CCW software limit setting is outside the settable range (-1,073,741,823 to 1,073,741,823).	
Sensor inputs	Emergency stop input	6000	An emergency stop signal has been input.	After clearing the emergency stop input, execute RELEASE PROHIBIT/ERROR RESET. For a limit input, execute RELEASE PROHIBIT/ERROR RESET and feed in the opposite direction from the limit stop. Check the axis parameters' signal type setting (N.C. or N.O.).
	CW limit stop	6100	A CW limit input signal has been input.	
	CCW limit stop	6101	A CCW limit input signal has been input.	

## 11-1-4 Command Execution Check

## Data Checks for Data-writing Commands

Item	Name	Code	Cause	Clearing method	Operation after error
Initial speed	Initial speed error	1000	The axis parameters' initial speed setting exceeds the maximum speed designation.	Transfer the data again after checking and correcting it.	When this error occurs during data transfer, all data (including the data with the error) specified for transfer will be lost. All operating axes will be decelerated to a stop.
	Initial pulse designation error	1001	The initial pulse designation is not set to 0000 or 0001.		
Maximum speed	Maximum speed error	1010	The axis parameters' maximum speed setting is outside the settable range (1 to 500 kpps).		
Acceleration/ deceleration data	Acceleration time error	1310	The axis parameters' origin search acceleration time setting is outside the settable range (0 to 250 s).		
	Acceleration time error	1311 to 1319	An acceleration time setting (1 to 9) is outside the settable range (0 to 250 s). (The rightmost digit of the error code indicates the setting with the error.)		
	Deceleration time error	1320	The axis parameters' origin search deceleration time setting is outside the settable range (0 to 250 s).		
	Deceleration time error	1321 to 1329	A deceleration time setting (1 to 9) is outside the settable range (0 to 250 s). (The rightmost digit of the error code indicates the setting with the error.)		
	Acceleration/deceleration curve error	1330	The axis parameters' acceleration/deceleration curve setting is not 0 or 1.		
	Positioning monitor time error	1332	The axis parameters' positioning monitor time is outside the settable range (0 to 9,999 ms).		
Speed data	Speed error	1500 to 1599	A speed setting is outside the settable range (1 pps to 1,000 kpps). (The last two digits of the code indicate the speed data number where the error occurred.)		
Origin search	Origin compensation error	1600	The axis parameters' origin compensation setting is outside the settable range (-1,073,741,823 to 1,073,741,823 pulses).		
	Origin search high speed error	1601	The axis parameters' origin search high speed setting exceeds the axis parameters' maximum speed setting.		
	Origin search proximity speed error	1602	The axis parameters' origin search proximity setting exceeds the axis parameters' maximum speed setting.		
	Origin search speed inconsistent	1603	The axis parameters' origin search high speed setting is less than or equal to the origin search proximity speed.		
	Origin mode selection error	1604	The axis parameters' origin search operating mode selection setting is not 0, 1, 2, or 3.		
	Origin search operation error	1605	The axis parameters' origin search operation setting is not 0, 1, or 2.		
	Origin search direction error	1606	The axis parameters' origin search direction is not 0 or 1.		

Item	Name	Code	Cause	Clearing method	Operation after error
Origin search (continued)	Origin detection method error	1607	Even though the axis parameters' origin search operation is not set to single-direction mode, the origin detection method setting is not 0, 1, or 2.	Transfer the data again after checking and correcting it.	When this error occurs during data transfer, all data (including the data with the error) specified for transfer will be lost.  All operating axes will be decelerated to a stop.
Backlash compensation	Backlash compensation error	1700	The axis parameters' backlash compensation setting is outside the settable range (0 to 9,999pulses).		
	Backlash compensation speed error	1710	The axis parameters' backlash compensation speed setting exceeds the maximum speed setting.		
Software limits	CW software limit error	1800	The axis parameters' CW software limit setting is outside the settable range (-1,073,741,823 to 1,073,741,823).		
	CCW software limit error	1801	The axis parameters' CCW software limit setting is outside the settable range (-1,073,741,823 to 1,073,741,823).		
Zones	Zone 0 CW error	1900	Zone 0's CW data is outside the settable range (-1,073,741,823 to 1,073,741,823).		
	Zone 0 CCW error	1901	Zone 0's CCW data is outside the settable range (-1,073,741,823 to 1,073,741,823).		
	Zone 1 CW error	1910	Zone 1's CW data is outside the settable range (-1,073,741,823 to 1,073,741,823).		
	Zone 1 CCW error	1911	Zone 1's CCW data is outside the settable range (-1,073,741,823 to 1,073,741,823).		
	Zone 2 CW error	1920	Zone 2's CW data is outside the settable range (-1,073,741,823 to 1,073,741,823).		
	Zone 2 CCW error	1921	Zone 2's CCW data is outside the settable range (-1,073,741,823 to 1,073,741,823).		
Position data	Target position error	2000 to 2099	The position data is outside the settable range (-1,073,741,823 to 1,073,741,823).  (The last two digits of the code indicate the position data number where the error occurred.)		

Item	Name	Code	Cause	Clearing method	Operation after error
Positioning sequences	Sequence data error	3000 to 3099	<p>One of the following errors occurred in the positioning sequence:</p> <p>The completion code is not in the range 0 to 6.</p> <p>The initial speed number is not in the range 00 to 99.</p> <p>The acceleration time number is not in the range 0 to 9.</p> <p>The deceleration time number is not in the range 0 to 9.</p> <p>The target speed number is not in the range 00 to 99.</p> <p>The dwell time number is not in the range 00 to 19.</p> <p>One of the following errors occurred in the axis designation:</p> <p>The Y, Z, or U axis was specified for a 1-axis Position Control Unit.</p> <p>The Z or U axis was specified for a 2-axis Position Control Unit.</p> <p>More than one axis is specified for interrupt feeding or speed control, or all axis designation settings are set to 0.</p> <p>(The last two digits of the code indicate the position data number (00 to 99) where the error occurred.)</p>	Transfer the data again after checking and correcting it.	<p>When this error occurs during data transfer, all data (including the data with the error) specified for transfer will be lost.</p> <p>All operating axes will be decelerated to a stop.</p>
Dwell times	Dwell time error	4001 to 4019	<p>These codes indicate that a dwell time is outside the settable range (0 to 9.99 s).</p> <p>(The last two digits of the code indicate the dwell time number (00 to 19) where the error occurred.)</p>		

## Initial Operation Error Checks and Checks During Operation

Group	Name	Code	Cause	Clearing method	Operation after error
Software limits	CW software limit value	5030	<p>If positioning were performed in response to one of the following commands with the specified position data, the CW software limit would be exceeded, so positioning cannot be started.</p> <ul style="list-style-type: none"> <li>• ABSOLUTE MOVEMENT, RELATIVE MOVEMENT, or PRESENT POSITION PRESET</li> <li>• Positioning commands used in memory operation (absolute or relative designation)</li> </ul> <p>The software limit was exceeded for interrupt feeding or speed control during memory operation.</p>	Start operation after correcting all of the position data and clearing the pulse output prohibited state.	<p>The current START command will not be executed.</p> <p>Or, the axes for which speed control or interrupt feeding is performed and which exceeded the software limit will decelerate to a stop.</p> <p>Operating axes will not be affected.</p>
	CCW software limit value	5031	<p>If positioning were performed in response to one of the following commands with the specified position data, the CCW software limit would be exceeded, so positioning cannot be started.</p> <ul style="list-style-type: none"> <li>• ABSOLUTE MOVEMENT, RELATIVE MOVEMENT, or PRESENT POSITION PRESET</li> <li>• Positioning commands used in memory operation (absolute or relative designation)</li> </ul> <p>The software limit was exceeded for interrupt feeding or speed control during memory operation.</p>		
Origin	Current position unknown	5040	<p>One of the following commands was attempted with an unknown origin.</p> <p>Memory operation with absolute values, ABSOLUTE MOVEMENT direct operation, TEACH, or ORIGIN RETURN</p>	Execute the command again after executing ORIGIN SEARCH or PRESENT POSITION PRESET and establishing the origin.	
Limit stop	Stopped at CW limit	5060	A CW-direction movement command was executed while the CW limit input signal was ON.	Move in the CCW direction.	
	Stopped at CCW limit	5061	A CCW-direction movement command was executed while the CCW limit input signal was ON.	Move in the CW direction.	
Software limits (JOG)	Manual CW software limit	5070	The CW software limit was exceeded during JOG operation.	After executing RELEASE PROHIBIT/ERROR RESET, move in the CCW direction.	<p>The axis that exceeded the software limit will be decelerated to a stop.</p> <p>Other operating axes will not be affected.</p>
	Manual CCW software limit	5071	The CCW software limit was exceeded during JOG operation.	After executing RELEASE PROHIBIT/ERROR RESET, move in the CW direction.	



Group	Name	Code	Cause	Clearing method	Operation after error
Sensor inputs	Emergency stop input	6000	The axis was stopped by an emergency stop signal input.	Start operation again after clearing the emergency stop input and executing RELEASE PROHIBIT/ERROR RESET.	An emergency stop will be performed on the affected axis. Other operating axes will not be affected.
	CW limit stop	6100	The axis was stopped by a CW limit input signal.	Move in the CCW direction after executing RELEASE PROHIBIT/ERROR RESET.	
	CCW limit stop	6101	The axis was stopped by a CCW limit input signal.	Move in the CW direction after executing RELEASE PROHIBIT/ERROR RESET.	
Origin search	No origin proximity input signal	6200	The Unit is set for a proximity input signal, but no origin proximity input signal was received during the origin search.	Perform the origin search again after checking the origin proximity input signal wiring and the origin proximity input signal type (N.C. or N.O.) in the axis parameters' I/O settings. If the signal type is changed, reset the power supply or restart the Position Control Unit before resuming operation.	Other operating axes will not be affected.
	No origin input signal	6201	There was no origin input signal received during the origin search.	Perform the origin search again after checking the origin input signal wiring and the origin input signal type (N.C. or N.O.) in the axis parameters' I/O settings. If the signal type is changed, reset the power supply or restart the Position Control Unit before resuming operation.	
	Origin input signal error	6202	There was an origin input signal received while decelerating after the origin proximity input signal was received during an origin search in mode 0.	Perform the following adjustments so that the origin signal will turn ON after deceleration is completed. <ul style="list-style-type: none"> <li>• Increase the distance between the sensors used for the origin input signal and the sensor used for the origin proximity input signal.</li> <li>• Decrease the origin search high speed and origin search proximity speed settings.</li> </ul>	The axis where the origin input signal was input will be decelerated to a stop. Other operating axes will not be affected.

Group	Name	Code	Cause	Clearing method	Operation after error
Origin search	Limit inputs in both directions	6203	Origin search cannot be executed because there are limit signals being input in both directions.	Perform the origin search again after checking the wiring and signal type in the axis parameters' I/O settings (N.C. or N.O.) for both directions. If the signal type is changed, reset the power supply or restart the Position Control Unit before resuming operation.	The origin search will not be executed, but other operating axes will not be affected.
	Simultaneous origin proximity and limit signals	6204	The origin proximity input and limit signal in the origin search direction were input simultaneously during the origin search.	Perform the origin search again after checking the wiring and signal types in the axis parameters' I/O settings (N.C. or N.O.) for the origin proximity and limit signals. If the signal type is changed, reset the power supply or restart the Position Control Unit before resuming operation.	An emergency stop will be performed on the axis where the signals were input. Other operating axes will not be affected.
	Limit input already being input	6205	There was already a limit signal in the origin search direction during an origin search in a single direction. The origin input signal and limit signal opposite the origin search direction were ON simultaneously or the limit input in the search direction went ON while the origin input signal was reversed during an origin search without proximity input signal.	Perform the origin search again after checking the wiring and signal type in the axis parameters' I/O settings (N.C. or N.O.) for the limit input. If the signal type is changed, reset the power supply or restart the Position Control Unit before resuming operation.	The current START command will not be executed. Pulse output for the axes for which the limit input signal was input will be stopped immediately. Other operating axes will not be affected.
	Origin proximity/origin reverse error	6206	The limit signal in the origin search direction was input while the origin proximity input signal was reversed during a proximity search with limit input reversal. The limit input signal in the origin search direction was received while the origin input signal was reversed during a proximity search with limit input reversal (not using the origin proximity input signal).	Perform the origin search again after checking the signal types in the axis parameters' I/O settings (N.C. or N.O.) and positions for the limit input signal, origin proximity input signal, and origin input signal inputs. If the signal type is changed, reset the power supply or restart the Position Control Unit before resuming operation.	An emergency stop will be performed on the axis where the signals were input. Other operating axes will not be affected.
	Origin search position error	6207	The position data is outside the settable range (-1,073,741,823 to 1,073,741,823 pulses).	Check the data that was transferred, correct any mistakes, and transfer the data again.	The current START command will not be executed, but other operating axes will not be affected.

Group	Name	Code	Cause	Clearing method	Operation after error
Absolute movement command	Absolute movement position error	7000	The position designation of the ABSOLUTE MOVEMENT command is outside the settable range (-1,073,741,823 to 1,073,741,823 pulses).	Execute the command again after correcting the position or speed designation to a value in the settable range.	The current START command will not be executed, but other operating axes will not be affected.
	Absolute movement speed error	7001	The speed designation for the ABSOLUTE MOVEMENT command is 0 or exceeds the axis parameters' maximum speed.		
	Absolute movement acceleration time error	7002	The acceleration time designation of the ABSOLUTE MOVEMENT command is outside the settable range (0 to 250 ms).		
	Absolute movement deceleration time error	7003	The deceleration time designation of the ABSOLUTE MOVEMENT command is outside the settable range (0 to 250 ms).		
Relative movement command	Relative movement position error	7100	The position designation of the RELATIVE MOVEMENT command is outside the settable range (-1,073,741,823 to 1,073,741,823 pulses).		
	Relative movement speed error	7101	The speed designation of the RELATIVE MOVEMENT command is 0 or exceeds the axis parameters' maximum speed.		
	Relative movement acceleration time error	7102	The acceleration time designation of the RELATIVE MOVEMENT command is outside the settable range (0 to 250 ms).		
	Relative movement deceleration time error	7103	The deceleration time designation of the RELATIVE MOVEMENT command is outside the settable range (0 to 250 ms).		
Interrupt feeding	Interrupt feeding position error	7200	The position designation of interrupt feeding is outside the settable range (-1,073,741,823 to 1,073,741,823 pulses).		
	Interrupt feeding speed error	7201	The speed designation of interrupt feeding is 0 or exceeds the axis parameters' maximum speed.		
	Interrupt feeding acceleration time error	7202	The acceleration time designation of interrupt feeding is outside the settable range (0 to 250 ms).		
	Interrupt feeding deceleration time error	7203	The deceleration time designation of interrupt feeding is outside the settable range (0 to 250 ms).		
Origin return	Origin return error	7300	The speed designation of origin return is 0 or exceeds the axis parameters' maximum speed.		
	Origin return acceleration time error	7301	The acceleration time designation of origin return is outside the settable range (0 to 250 s).		
	Origin return deceleration time error	7302	The deceleration time designation of origin return is outside the settable range (0 to 250 s).		
Present position	Present position error	7400	The position specified with present position preset is outside the settable range (-1,073,741,823 to 1,073,741,823).		

Group	Name	Code	Cause	Clearing method	Operation after error
JOG	JOG speed error	7500	The JOG speed is 0 or exceeds the axis parameters' maximum speed.	Execute the command again after correcting the position or speed designation to a value in the settable range.	The current START command will not be executed, but other operating axes will not be affected.
	JOG acceleration time error	7501	The JOG acceleration time is outside the settable range (0 to 250 s).		
	JOG deceleration time error	7502	The JOG deceleration time is outside the settable range (0 to 250 s).		
Multiple axis start	Multiple axis start	8000	Two or more of the following commands were executed simultaneously for the same axis: START, INDEPENDENT START, ORIGIN SEARCH, ORIGIN RETURN, PRESENT POSITION PRESET, JOG, TEACH, RELEASE PROHIBIT/ERROR RESET, ABSOLUTE MOVEMENT, RELATIVE MOVEMENT, or INTERRUPT FEEDING	Correct the ladder program so that just one command is executed for each axis at one time and execute the command again.	The command will not be executed. If the last command made before the error was START, INDEPENDENT START, ORIGIN SEARCH, ORIGIN RETURN, JOG, ABSOLUTE MOVEMENT, RELATIVE MOVEMENT, or INTERRUPT FEEDING, the axis with the error will be decelerated to a stop. When interpolation operation is being used, all interpolated axes will be decelerated to a stop. If the error is generated during data transfer (read or write) or data saving, all axes will be decelerated to a stop. Any operating axes not specified above will not be affected.
			One of the following commands was executed for a busy axis: ORIGIN SEARCH, ORIGIN RETURN, PRESENT POSITION PRESET, JOG, TEACH, RELEASE PROHIBIT/ERROR RESET, ABSOLUTE MOVEMENT, RELATIVE MOVEMENT, or INTERRUPT FEEDING	Correct the ladder program so that a command is not executed for a busy axis and execute the command again.	
			A data save operation was executed while one of the following commands was in progress: START, INDEPENDENT START, ORIGIN SEARCH, ORIGIN RETURN, PRESENT POSITION PRESET, JOG, TEACH, RELEASE PROHIBIT/ERROR RESET, ABSOLUTE MOVEMENT, RELATIVE MOVEMENT, or INTERRUPT FEEDING	Correct the ladder program so that the data save operation is executed while none of the axes are busy. Execute the data save operation again.	
			Two or more of the following commands were executed: DATA WRITE, DATA READ, or DATA SAVE	Correct the ladder program so that more than one data transfer (read or write) or data save operation is not executed at the same time. Execute the data transfer or data save operation again.	
			A START or INDEPENDENT START command was executed for a different axis, but a busy axis was specified in the axis designation.	Correct the ladder program so that busy axes are not specified for memory operation and execute the command again.	

Group	Name	Code	Cause	Clearing method	Operation after error
Multiple axis start	Multiple axis start	8000	One of the following commands was executed while the Data Transferring Flag was ON: DATA WRITE, DATA READ, or DATA SAVE	Correct the ladder program so that data transfer (read or write) or data save operation is not executed while the Data Transferring Flag is ON. Execute the data transfer or data save operation again.	The command will not be executed.  If the last command made before the error was START, INDEPENDENT START, ORIGIN SEARCH, ORIGIN RETURN, JOG, ABSOLUTE MOVEMENT, RELATIVE MOVEMENT, or INTERRUPT FEEDING, the axis with the error will be decelerated to a stop.  When interpolation operation is being used, all interpolated axes will be decelerated to a stop.  If the error is generated during data transfer (read or write) or data saving, all axes will be decelerated to a stop.  Any operating axes not specified above will not be affected.
Memory operation	Sequence number error	8101	There was a memory operation command and the Sequence Number Enable Bit was ON, but the specified sequence number was outside the settable range (00 to 99).	Execute the command again after checking the sequence number.	The current START command will not be executed, but other operating axes will not be affected.
			The Sequence Number Enable Bit was OFF, or the FORCED INTERRUPT Bit was ON, when memory operation was executed after the power was turned ON or the Position Control Unit was restarted, or after an origin search, origin return, or present position preset.	Execute the command again after changing the turning ON the Sequence Number Enable Bit.  Change the ON timing for the FORCED INTERRUPT Bit.	
			The axis designations for the specified sequence number's sequence data were all set to 0.	Execute the command again after correcting the sequence data.	
			The FORCED INTERRUPT Bit was turned ON after a bank end completion in memory operation.	Change the ON timing for the FORCED INTERRUPT Bit.	
	Speed error	8104	When positioning with memory operation, the speed specified in the sequence data was set to 0.	Execute the command again after checking the speed data and sequence data to make sure that the target speed is not 0.	

Group	Name	Code	Cause	Clearing method	Operation after error
Teaching	Teaching address error	8200	There was a TEACH command, but the teaching position number was not in the range 00 to 99.	Execute the command again after correcting the teaching position number.	The current START command will not be executed, but other operating axes will not be affected.
	Teaching range error	8201	Teaching cannot be performed because the present position is outside the range -1,073,741,823 to 1,073,741,823 pulses.	Change the present position on the axis (e.g., using JOG) and perform teaching again.	
Data transfer	Write transfer: number of words error	8310	The number of write words was set to 0 or exceeded the number of write data words. The parameters for the origin search high speed and the origin search proximity speed were not sent together.	Execute the command again after changing the incorrect setting.	The current START command will not be executed, but other operating axes will not be affected.
	Write transfer: source word error	8311	The write source word or the write source area was outside the settable range.		
	Write transfer: destination address error	8312	The write destination address was outside the settable range.		
	Read transfer: number of words error	8320	The number of read words was set to 0 or exceeded the number of read data words.		
	Read transfer: source address error	8321	The read source address was outside the settable range.		
	Read transfer: destination word error	8322	The read destination word or the read destination area was outside the settable range.		
Error counter reset/ Origin adjustment output	Error counter reset/ Origin adjustment error	8400	There was an attempt to output a error counter reset/origin adjustment output when the output couldn't be used.	Execute the command again after checking that the output can be used and changing the ladder program if necessary.	The axis will be decelerated to a stop. Other operating axes will not be affected.
Override	Override error	8500	The override setting was outside the settable range (1% to 999%).	Execute the command again after correcting the data.	
Positioning	Positioning timer timeout	8600	The Servo Driver's positioning completed signal did not go ON within the axis parameters' specified time.	Execute the command again after making adjustments such as adjusting the positioning monitor time or the servo system's gain, or checking the wiring for the positioning completed signal and correcting if necessary.	The specified axis will be decelerated to a stop. Other operating axes will not be affected.
	Overflow	8601	The movement distance is too long (greater than 2,147,483,646 pulses, or greater than 2,147,483,520 pulses for linear interpolation) and so operation is not possible.	Execute the command again after reducing the distance to move in one operation (by changing the position data).	The specified axis will be decelerated to a stop. Other operating axes will not be affected.

Group	Name	Code	Cause	Clearing method	Operation after error
Intelligent Read/Write	IORD format error	8700	One of the following errors occurred when the IORD instruction was executed: The Position Control Unit's address was outside the settable range.	Execute the instruction again after correcting the data.	The current data transfer will not be executed, but other operating axes will not be affected.
	IOWR format error	8701	One of the following errors occurred when the IOWR instruction was executed: The Position Control Unit's address was outside the settable range. The parameters for the origin search high speed and the origin search proximity speed were not sent together.		
Flash memory	Flash memory error	9300	An attempt was made to save data to flash memory, but the data couldn't be saved because of a problem with the flash memory.	Execute the data save operation again. The error will be cleared if the data is written normally. Replace the Unit if the error occurs again. (In some cases the data save operation can take up to 30 s.)	The current instruction will not be executed. All axes will be decelerated to a stop.

## 11-2 Troubleshooting

Error message, "A Communication error occurred" may be displayed during CX-Position operation. The following flowchart shows the causes and remedies.

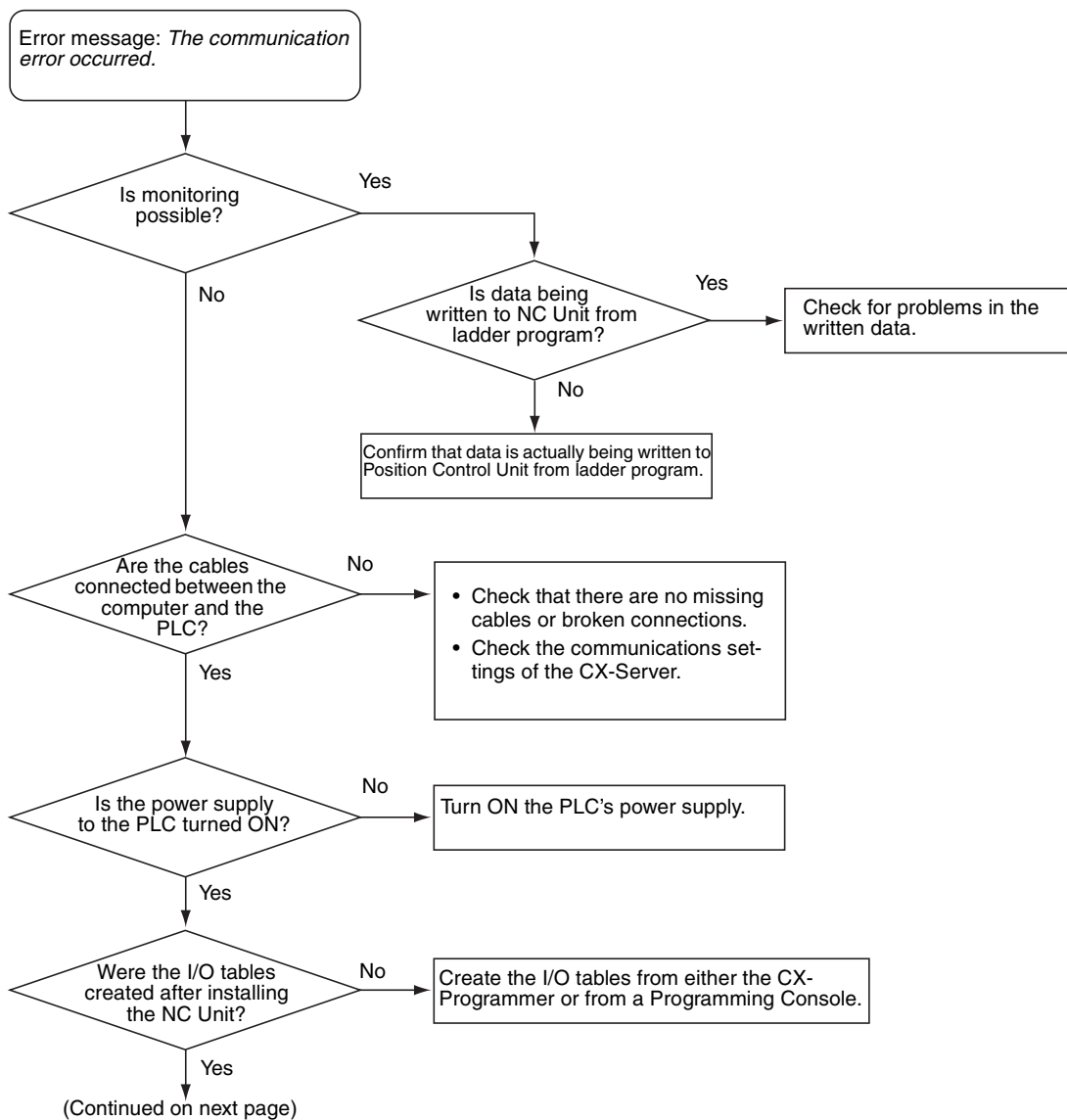



(Continued from previous page)

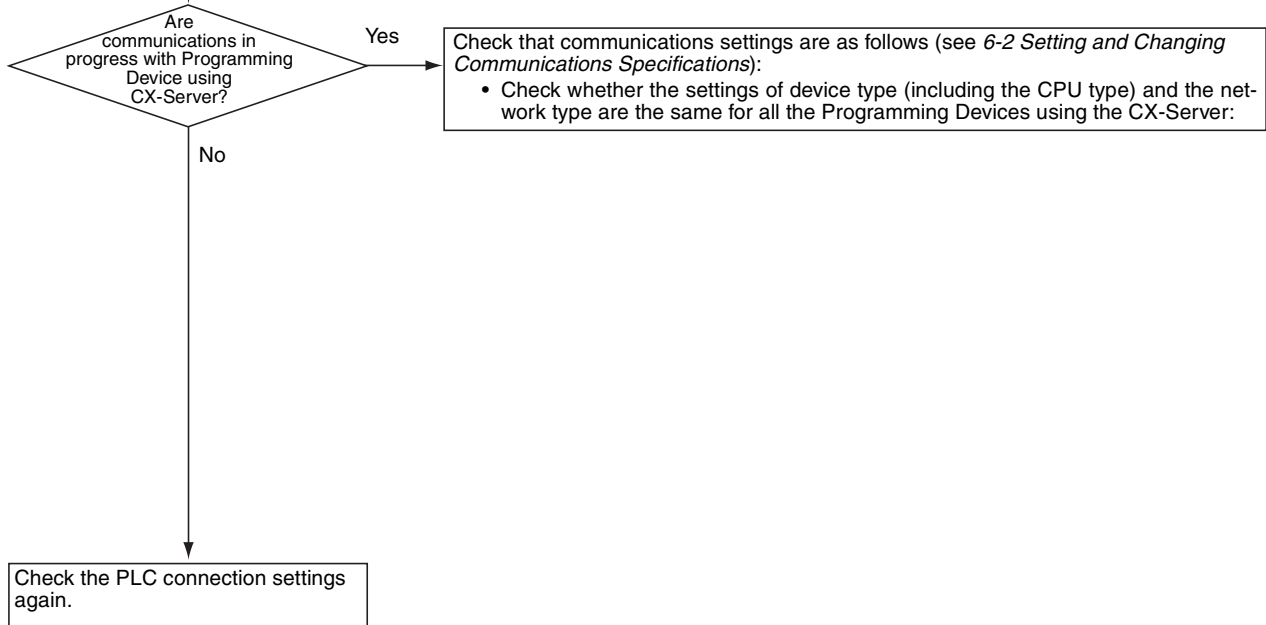

## Revision History

A manual revision code appears as a suffix to the catalog number on the front cover of the manual.

Cat. No. W433-E1-06

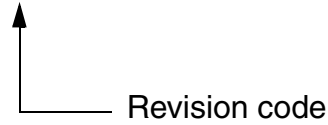

The following table outlines the changes made to the manual during each revision. Page numbers refer to the previous version.

Revision code	Date	Revised content
01	January 2004	Original production
02	February 2005	<p>Globally changed “PC” to “PLC” in the sense of “Programmable Controller.”</p> <p><b>Page v:</b> Changed signal word definitions.</p> <p><b>Page vii:</b> Unit version table and version upgrade information updated.</p> <p><b>Page xi:</b> Paragraph and table added on CX-One.</p> <p><b>Page xii:</b> Three pages added.</p> <p><b>Page xv:</b> Information on changing Startup Mode added toward bottom of page.</p> <p><b>Pages 2, 20 to 22, 39, 42 to 44, 50, 53, 57, 71, 72, 75, 80, and 81:</b> Graphics replaced.</p> <p><b>Page 3:</b> Information added before 1-1-4.</p> <p><b>Page 4:</b> CX-Server version updated to “2.3.”</p> <p><b>Page 4:</b> Package list revised.</p> <p><b>Page 5:</b> “CS1” changed to “CS.”</p> <p><b>Pages 10 to 14:</b> Installation information completely revised.</p> <p><b>Page 19:</b> Paragraph added at bottom of page and first two steps in procedure changed.</p> <p><b>Pages 24, 27, and 30:</b> Information added on online registration.</p> <p><b>Page 36:</b> Information added at bottom of page.</p> <p><b>Page 38:</b> Information added at top and bottom of page.</p> <p><b>Page 39:</b> Notes removed from bottom of page.</p> <p><b>Page 40:</b> “2 s” changed to “1 s” at bottom of page.</p> <p><b>Page 41:</b> CX-Programmer manual information updated.</p> <p><b>Page 42:</b> Sentences starting “baud rate auto-detect” changed.</p> <p><b>Page 46:</b> Additions made to table.</p> <p><b>Page 47:</b> Notes added.</p> <p><b>Page 66:</b> Information added before 5-2.</p> <p><b>Page 67:</b> Information added before 5-2-2.</p> <p><b>Page 70:</b> “Programming Console” changed to “PLC Setup.”</p> <p><b>Page 71:</b> Section reference information changed in middle of page.</p> <p><b>Page 72:</b> Section reference information changed at top of page.</p> <p><b>Page 80:</b> Information added at bottom of page.</p> <p><b>Page 82:</b> “Online help” added.</p> <p><b>Page 99:</b> Error with error code 6207 added.</p>

## Revision History

Revision code	Date	Revised content
03	November 2005	<p>Writing style unified for certain aspects of the manual. The following changes were made to update to version 2.1 and correct information in the manual.</p> <p><b>Pages vii, viii, and ix:</b> Version information added. <b>Page xx:</b> Caution added. <b>Pages 2, 24, and 78:</b> NSJ Series added. <b>Page 3:</b> "S" removed from model number. <b>Page 4:</b> Second paragraph in <i>1-1-6 Software Structure</i> removed. <b>Pages 6, 31, and 35:</b> Test run operation and error counter reset output function added. <b>Page 48:</b> CX-Programmer version updated. <b>Page 78:</b> "Toolbus" added. <b>Page 91:</b> Two new sections added.</p>
04	July 2006	<p>Manual was updated to version 2.3, including the addition of origin search and direction operation functions in test run execution from the CX-Position.</p> <p><b>Page ix:</b> Version information added. <b>Page 6:</b> Details of "test run" updated. <b>Section 8-2:</b> Updated to include origin search and direction operation functions.</p>
05	June 2007	<p><b>Page ix:</b> Version upgrade information added for version 2.4. <b>Page xiii:</b> First paragraph changed, table changed, and CX-One version updated. <b>Page 2:</b> Applicable OS updated and table and note changed. <b>Page 4:</b> First paragraph changed, table removed, and section 1-1-7 removed. <b>Page 5:</b> Note 1 changed. <b>Page 10:</b> "Types of CX-Position" changed to "Installing CX-Position," next paragraph removed, and CX-One version updated. <b>Pages 10 to 19:</b> Section 2-1-2 to end of section 2-1 removed. <b>Page 24:</b> Section added before section 2-3.</p>
06	June 2008	<p><b>Page ix:</b> Added version upgrade information. <b>Page xiii:</b> Corrected applicable OS's, corrected model numbers, and corrected software version. <b>Page 2:</b> Changed applicable OS's. <b>Page 5:</b> Removed note. <b>Page 10:</b> Corrected model numbers, corrected software version, and replaced first paragraph in section 2-2. <b>Page 15:</b> Added new section (2-2-3).</p>